

8162500COM Display Storage

Ameriwood
HOME

Date of Purchase ___ / ___ / ___
Lot Number:

B348162500COM0

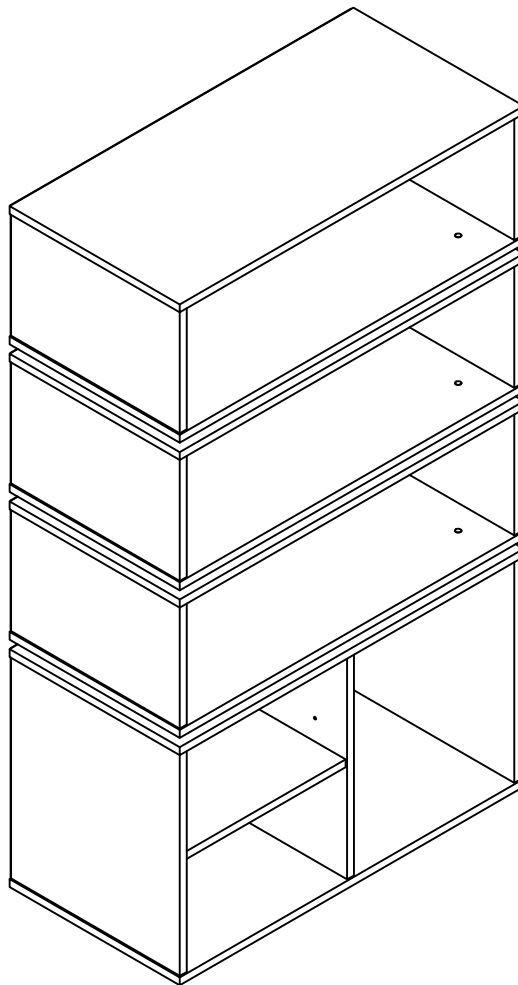

Do Not Return This Product!
Contact our customer service team for help first.
Call: 1-800-489-3351 (toll free)
Monday-Friday 9am - 5pm CST
Visit: www.ameriwoodhome.com

THIS INSTRUCTION BOOKLET CONTAINS **IMPORTANT** SAFETY INFORMATION. PLEASE READ AND KEEP FOR FUTURE REFERENCE.

Secure Your Furniture

Keep your home and family safe with the wall anchor kit that is included with the product.

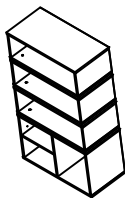

Serious or fatal crushing injuries can occur from tipping furniture.

WARNING: Manufacturer assumes no liability for improper installation or excessive loads placed on screws or bracket. This wall anchor is not a substitute for proper adult supervision.



Follow Ameriwood Home



Contact Us!

Do NOT return this product!

Contact our friendly customer service team first for help.



Visit ameriwoodhome.com to view the limited warranty valid in the U.S. and Canada.

Assembly Tips



Helpful Hints

PEOPLE NEEDED FOR ASSEMBLY: 1-2

- Open your item in the area you plan to keep it to avoid excessive heavy lifting.
- Identify, sort and count the parts before attempting assembly.
- Compression dowels are lightly tapped in with a hammer.
- Slides are labeled with a **R** (right) and **L** (left) for proper placement.
- Make sure to always face the point on the top of the Cam Lock towards the outer edge.
- Use all the nails provided for the back panel and spread them out equally.
- Back panel must be used to make sure your unit is sturdy.
- Do NOT use harsh chemicals or abrasive cleaners on this item.
- Never push, pull, or drag your furniture.



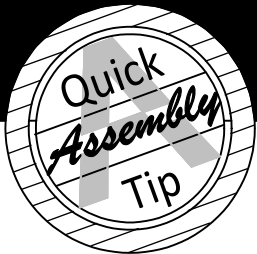

Before You Start



- ✓ Read through each step carefully and follow the proper order
- ✓ Separate and count all your parts and hardware
Parts are labeled on the surface or edge of the part
- ✓ Give yourself enough room for the assembly process
- ✓ Have the following tools: Flat Head Screwdriver, #2 Phillips Head Screwdriver and Hammer
- ✓ Caution: If using a power drill or power screwdriver for screwing, please be aware to slow down and stop when screw is tight. Failure to do so may result in stripping the screw.

Cam Lock Fastening System

This Cam Lock Fastening System will be used throughout the assembly process.

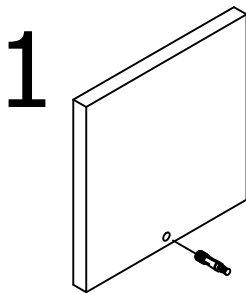

1 Press CAM BOLT into hole.

2

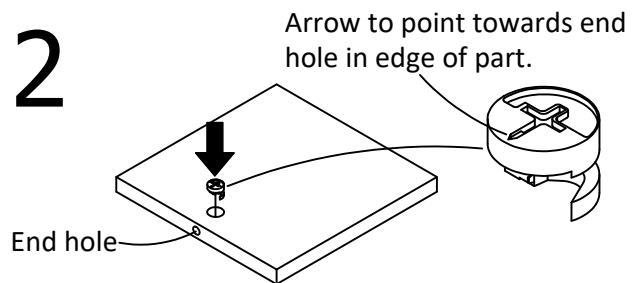

2 Press CAM LOCK into hole.

3

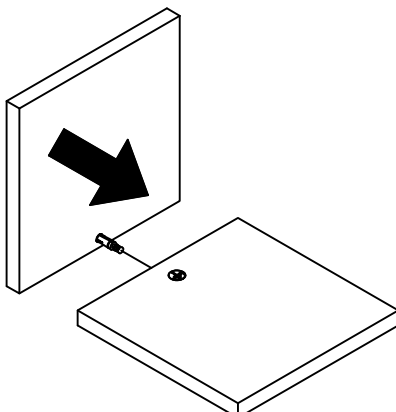

3 Press parts together so CAM BOLT inserts into edge hole.

4

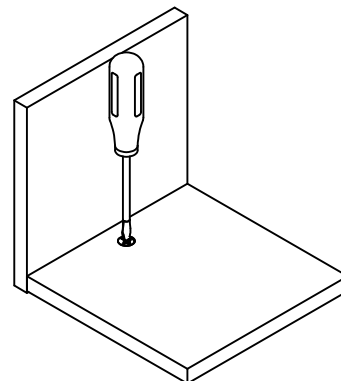

4 Using a screwdriver, turn the CAM LOCK clockwise to lock the CAM LOCK and CAM BOLT into their holes and fastening parts together.

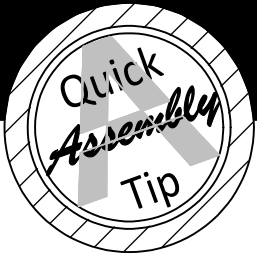

Before You Start

Please Note:

You may need to lightly tap the wood dowels into the holes during your assembly process.

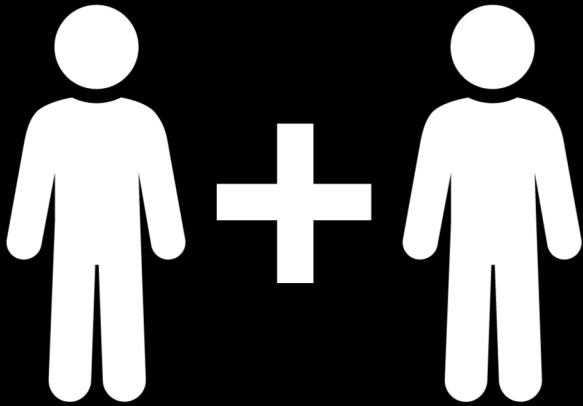
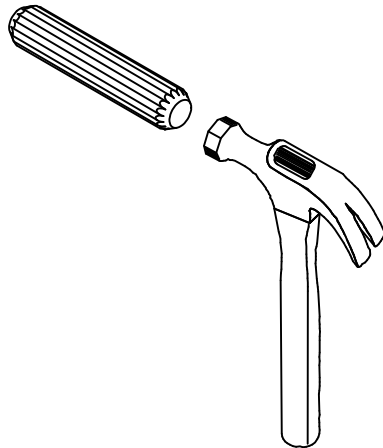

2 PEOPLE NEEDED FOR ASSEMBLY

**2 PERSONAS NECESITADAS
PARA LA ASAMBLEA**

**2 PERSONNES NÉCESSAIRES
POUR L'ASSEMBLAGE**

CAUTION: Failure to use 2 people for assembly could result in unit damage or personal injury.

PRECAUCIÓN: Si no se utilizan 2 personas para el ensamblaje, se pueden producir daños en la unidad o lesiones personales.

ATTENTION: Échec d'utiliser 2 personnes pour l'assemblage peut causer du dommage au meuble ou causer des blessures.

Board Identification

Not actual size

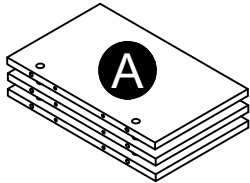

Left Upper Panel (x3)
38162352010

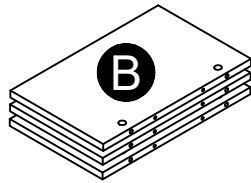

Right Upper Panel (x3)
38162352020

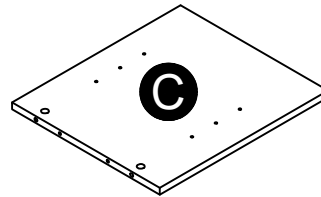

Left Lower Panel
38162352030

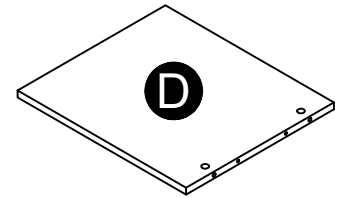

Right Lower Panel
38162352040

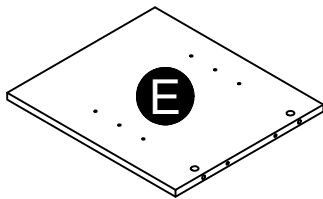

Partition
38162315050

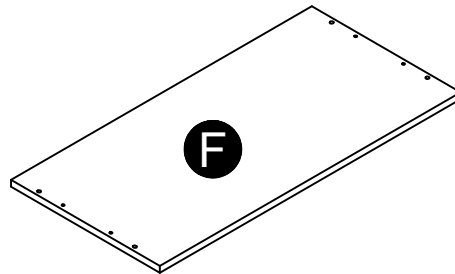

Top
38162352060

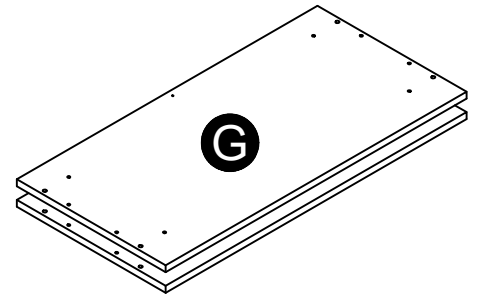

Upper Shelf (x2)
38162352070

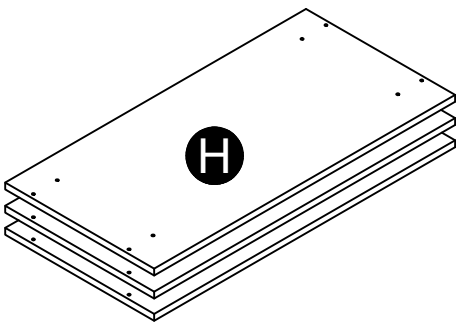

Lower Shelf (x3)
38162352080

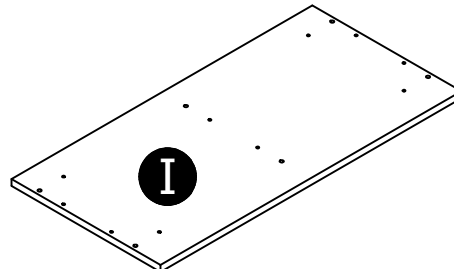

Fix Shelf
38162352090

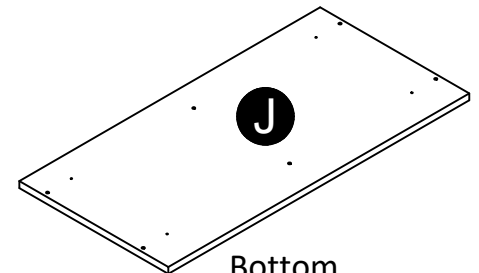

Bottom
38162315100

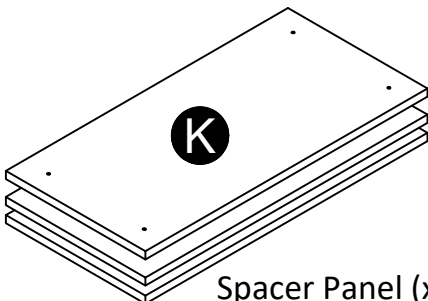

Spacer Panel (x3)
38162315110

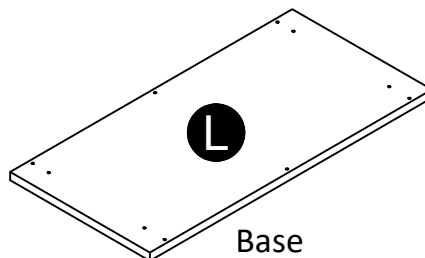

Base
38162315120

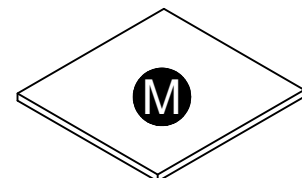

Adjustable Shelf
38162315130

Board Identification

Not actual size

These pieces are paperboard construction.
They are not made from wood, but are
required for the assembly of your unit.

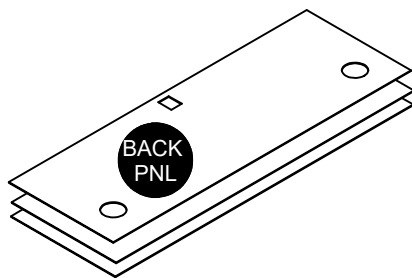

Upper Back Panel (x3)
K816231500

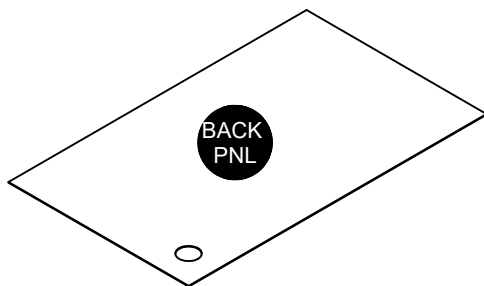

Lower Back Panel
K816231510

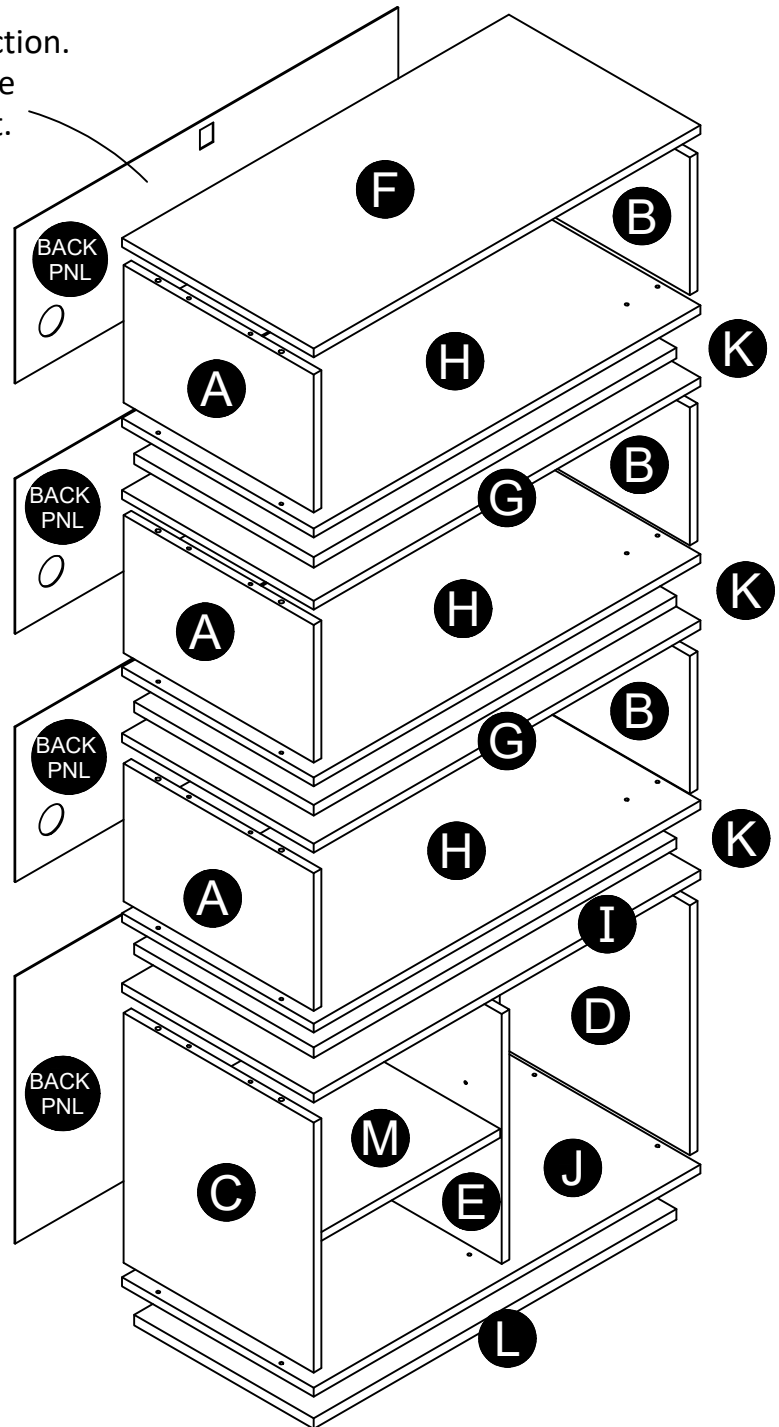

Part List

Actual Size

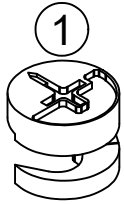

(x28)
#A22700
cam lock

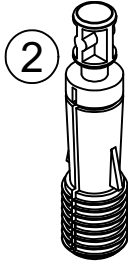

(x28)
#A22710
cam bolt



(x24)
#A21670
wood dowel

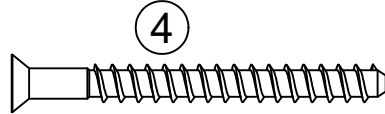

(x18)
#A23030
confirmat

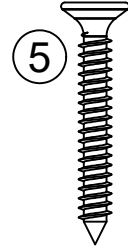

(x4)
#A13050
#8 screw

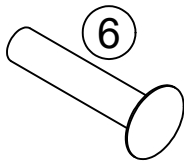

(12)
#A22945
chicago fastener

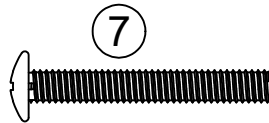

(12)
#A17630
1-1/4" bolt



(x6)
#A89370
door bumper



(x98)
#A21110
nail



(x4)
#A80250
shelf support

Not Actual Size

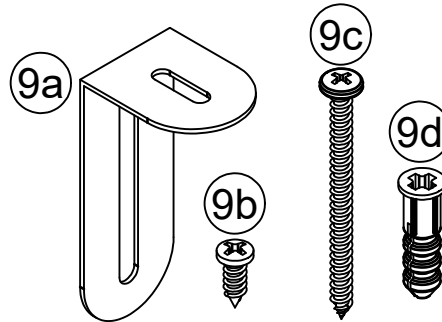

(x1)
#A84050
safety bracket kit

STEP 1

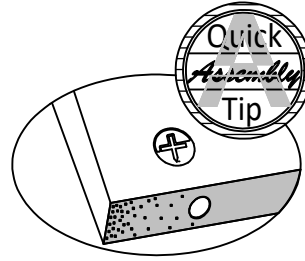
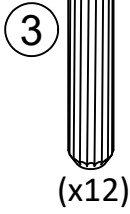
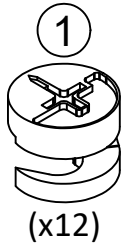

Proper orientation of CAM LOCK

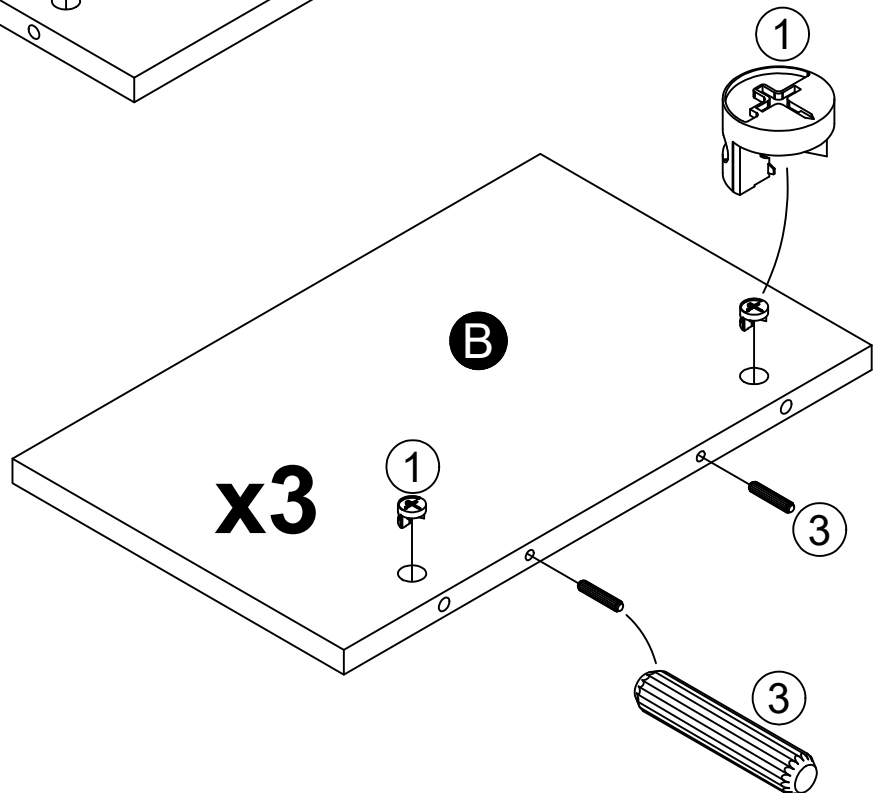
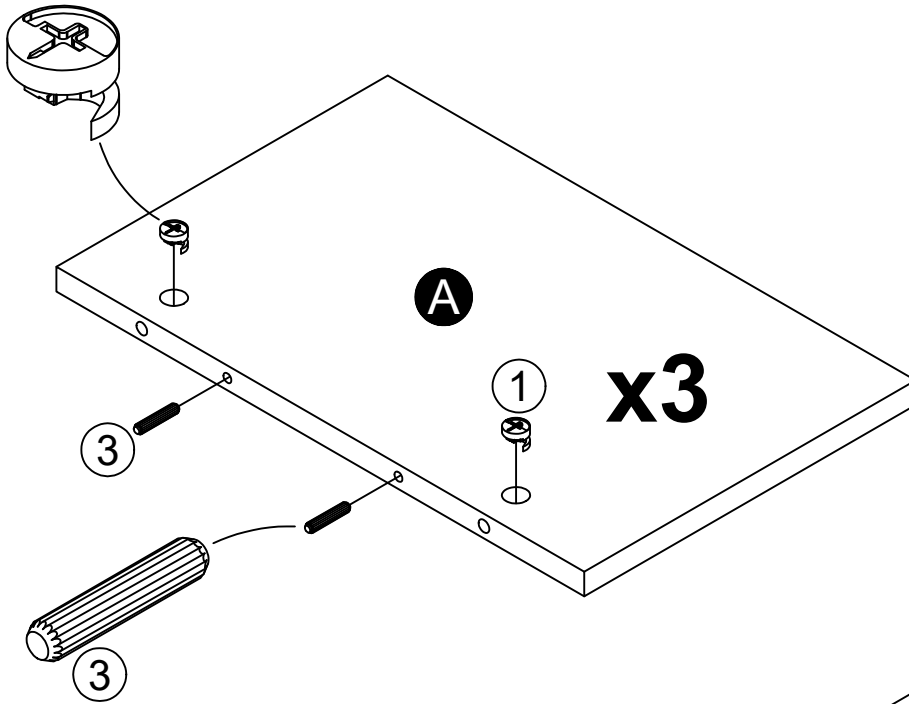

STEP 2

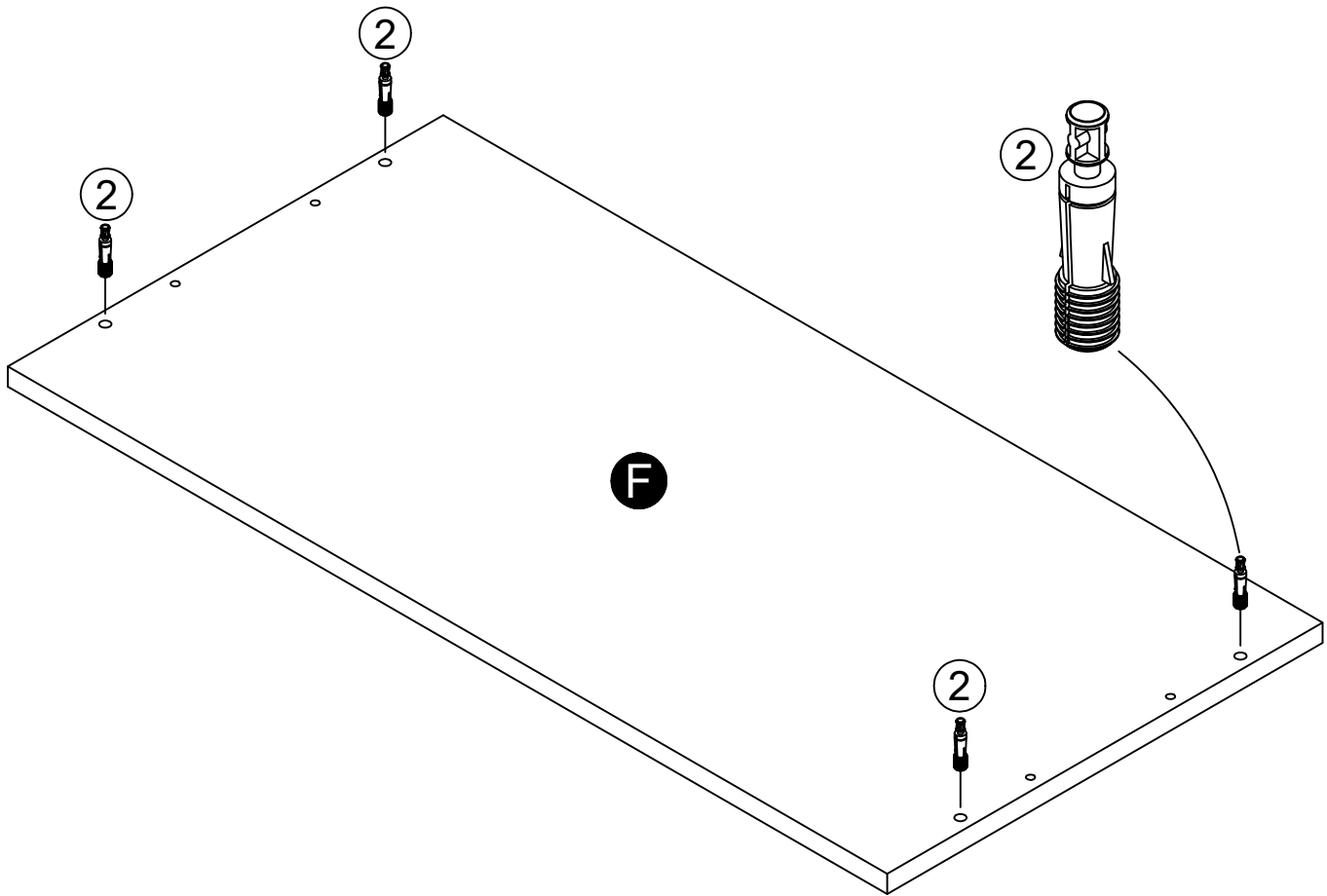
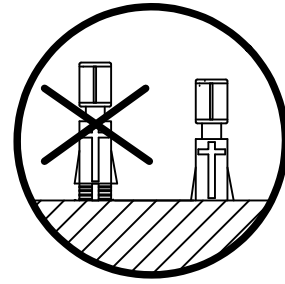
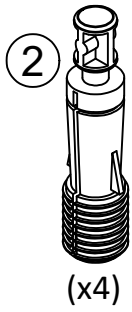

STEP 3

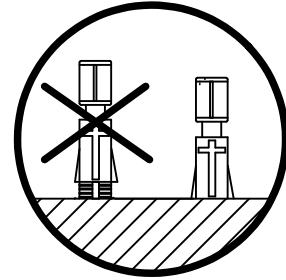
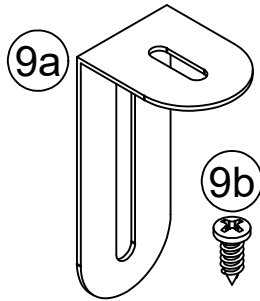
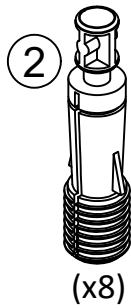
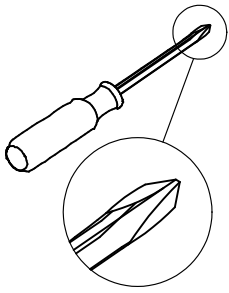

Do not fully tighten screw.

NOTE:
You will attach the safety bracket to one (1) Upper Shelf (G).

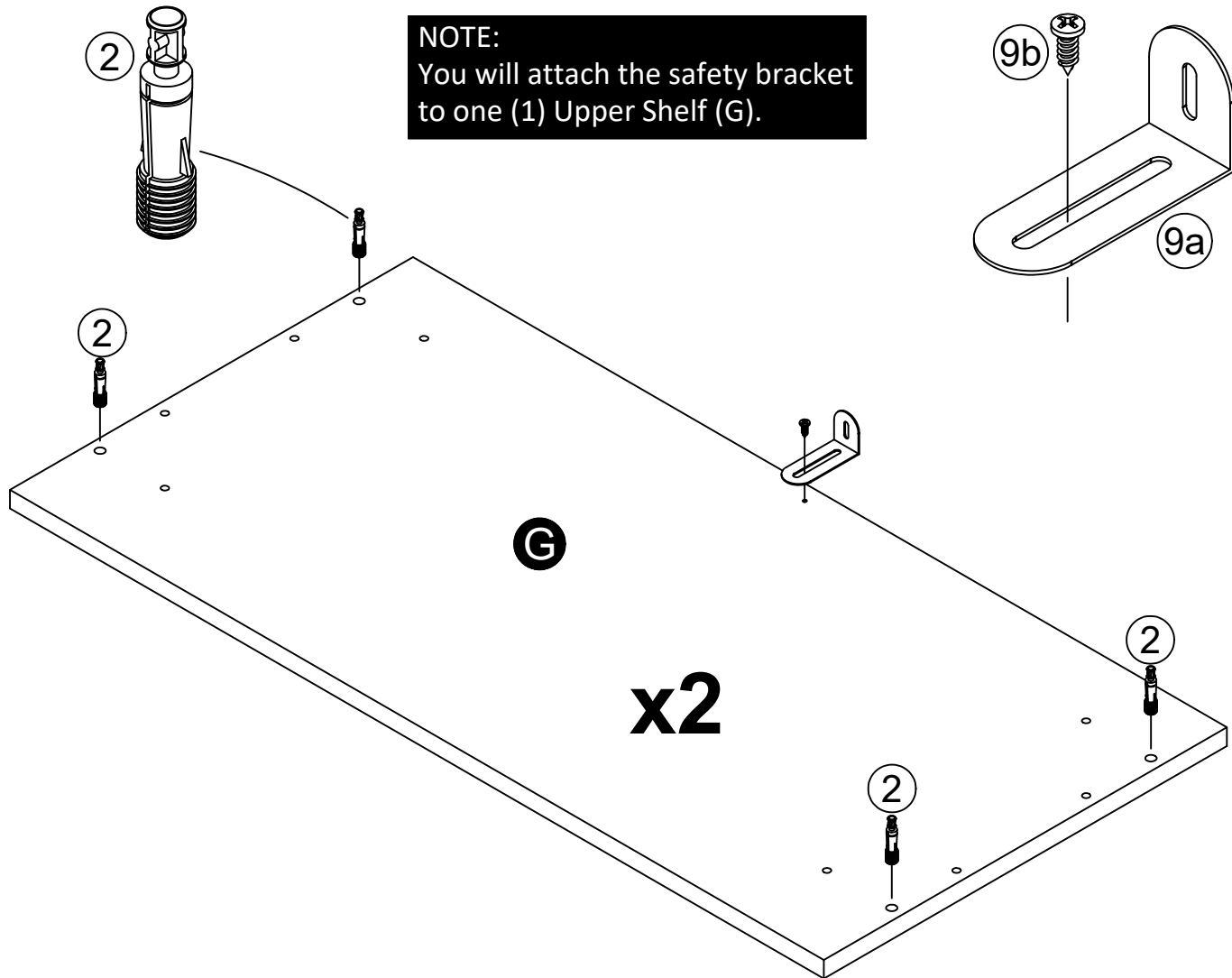

STEP 4

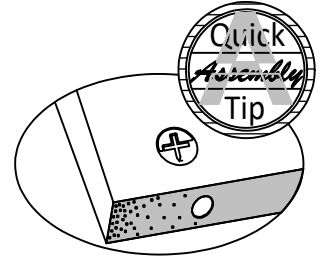
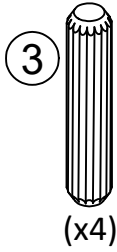
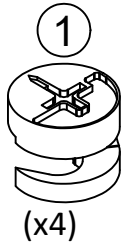

Proper orientation of CAM LOCK

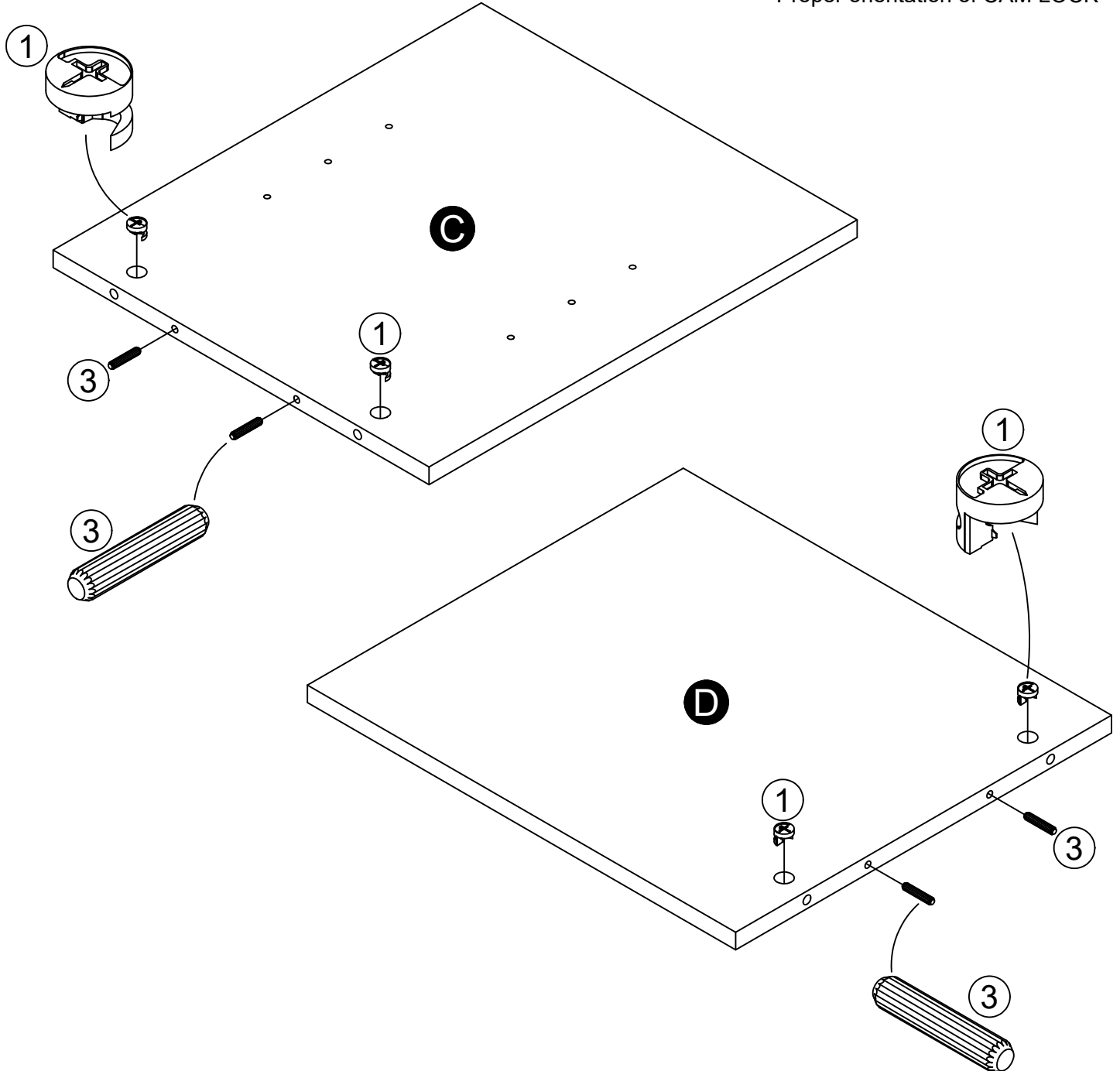

STEP 5

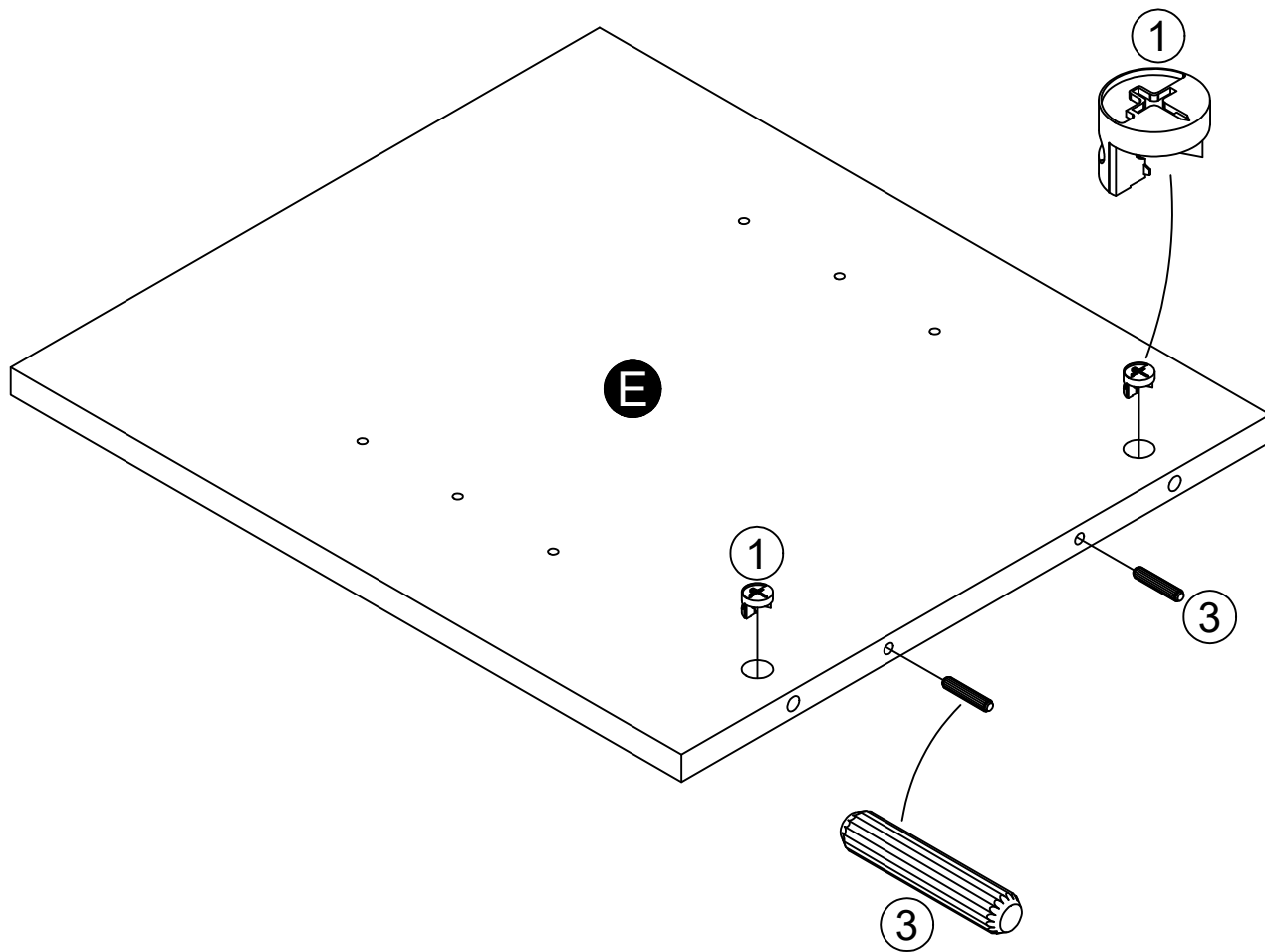
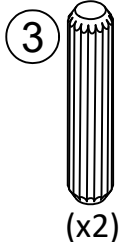
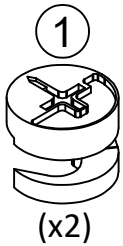

STEP 6

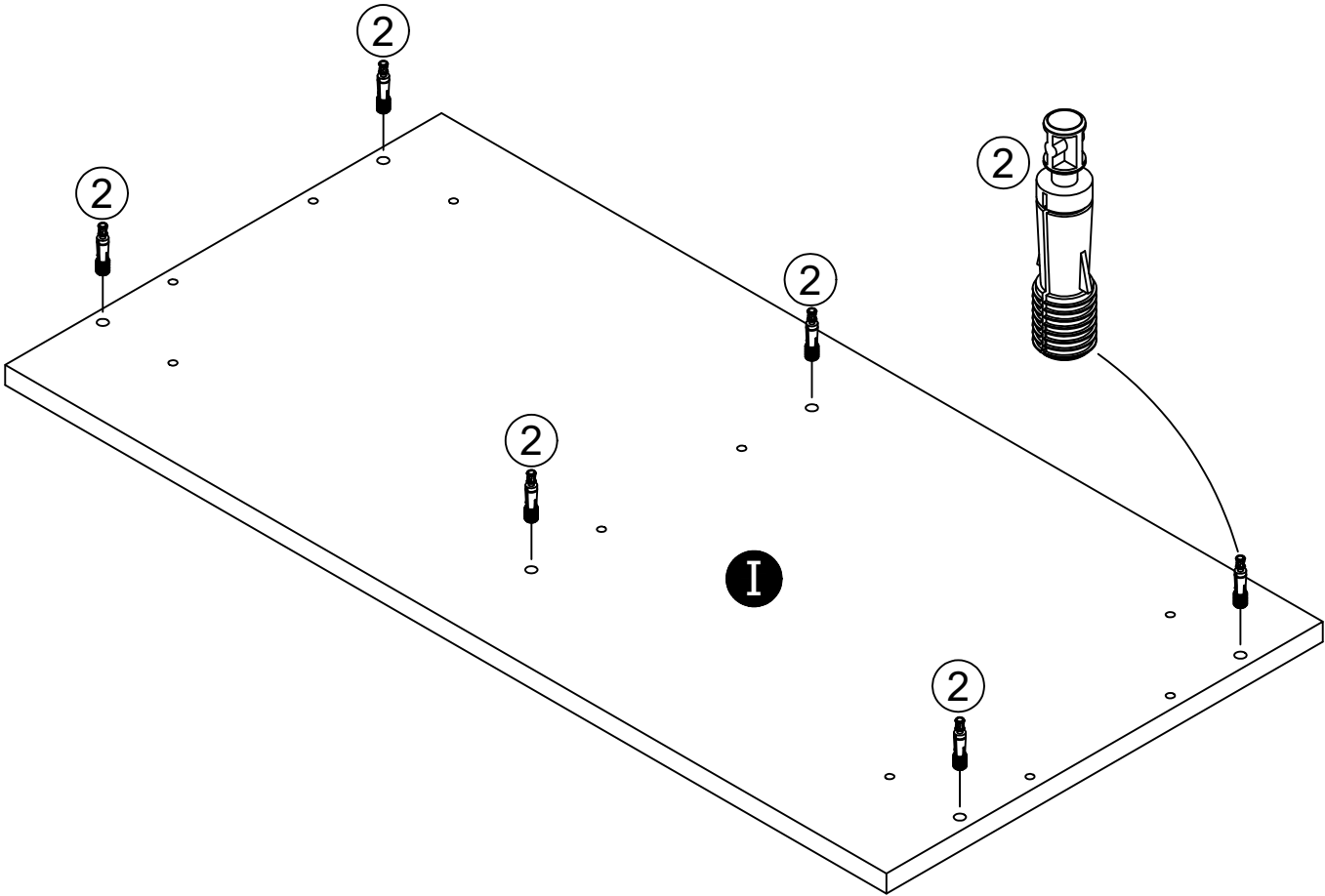
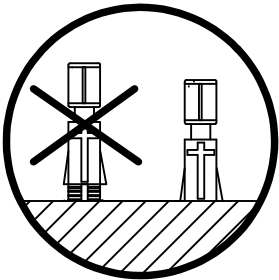
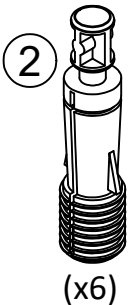

STEP 7

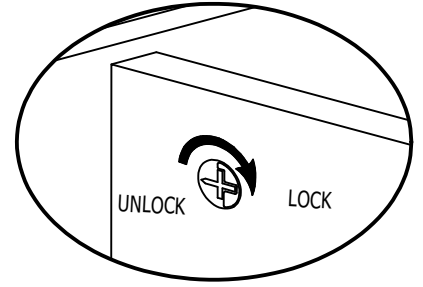
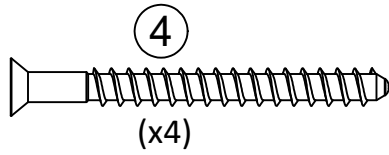
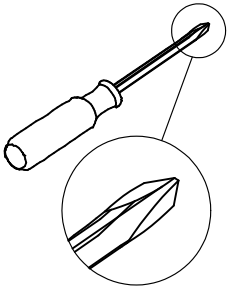

finished edges face up

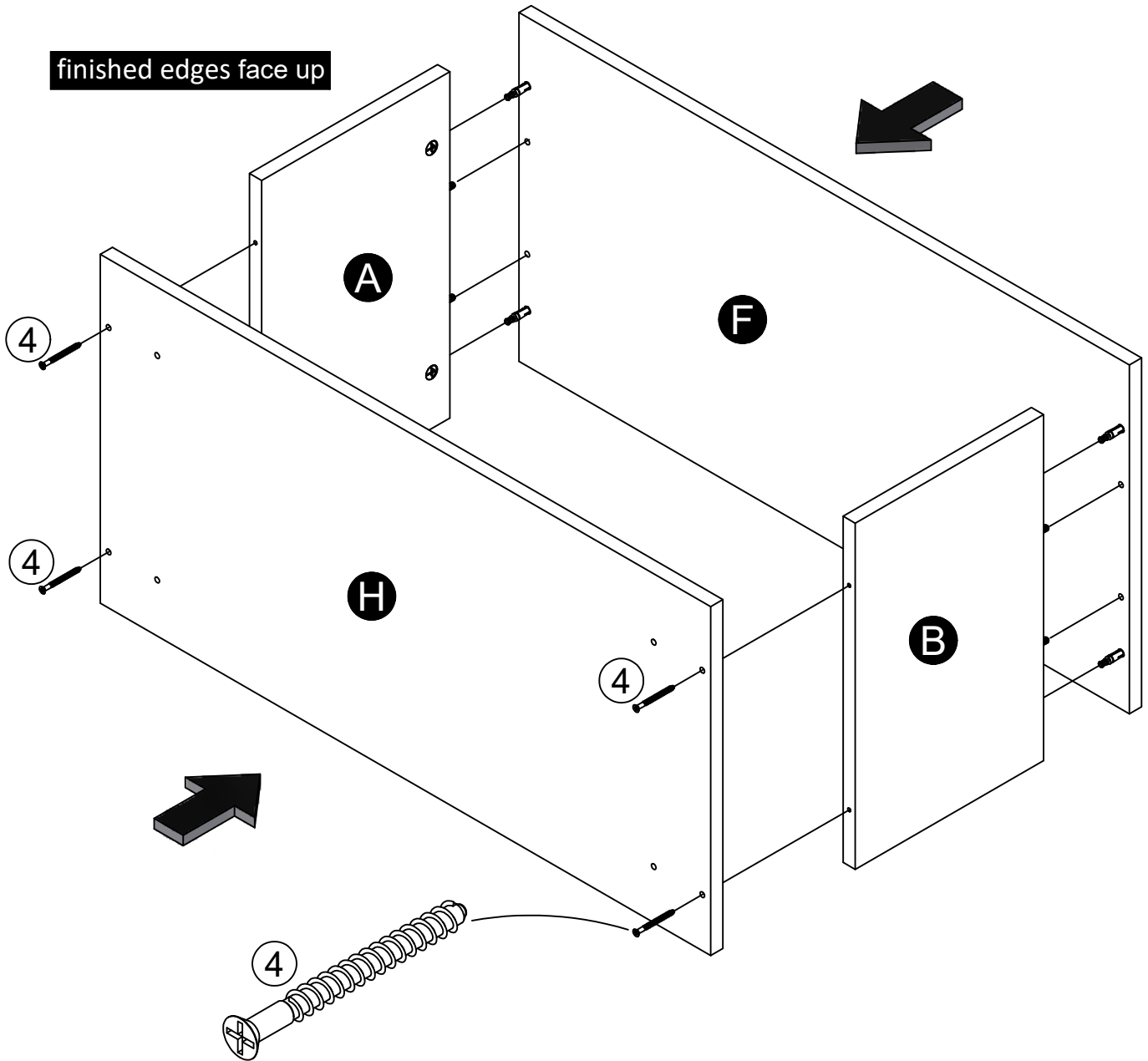

STEP 8

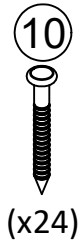
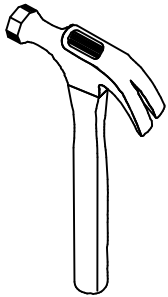

IMPORTANT! THE BACK PANEL IS A STRUCTURAL PART OF THIS UNIT AND MUST BE INSTALLED PROPERLY.

Attached the back panel as shown nailing straight into the raw edges.

Assure that the cube is square. Distance from corner to corner must be equal as shown.

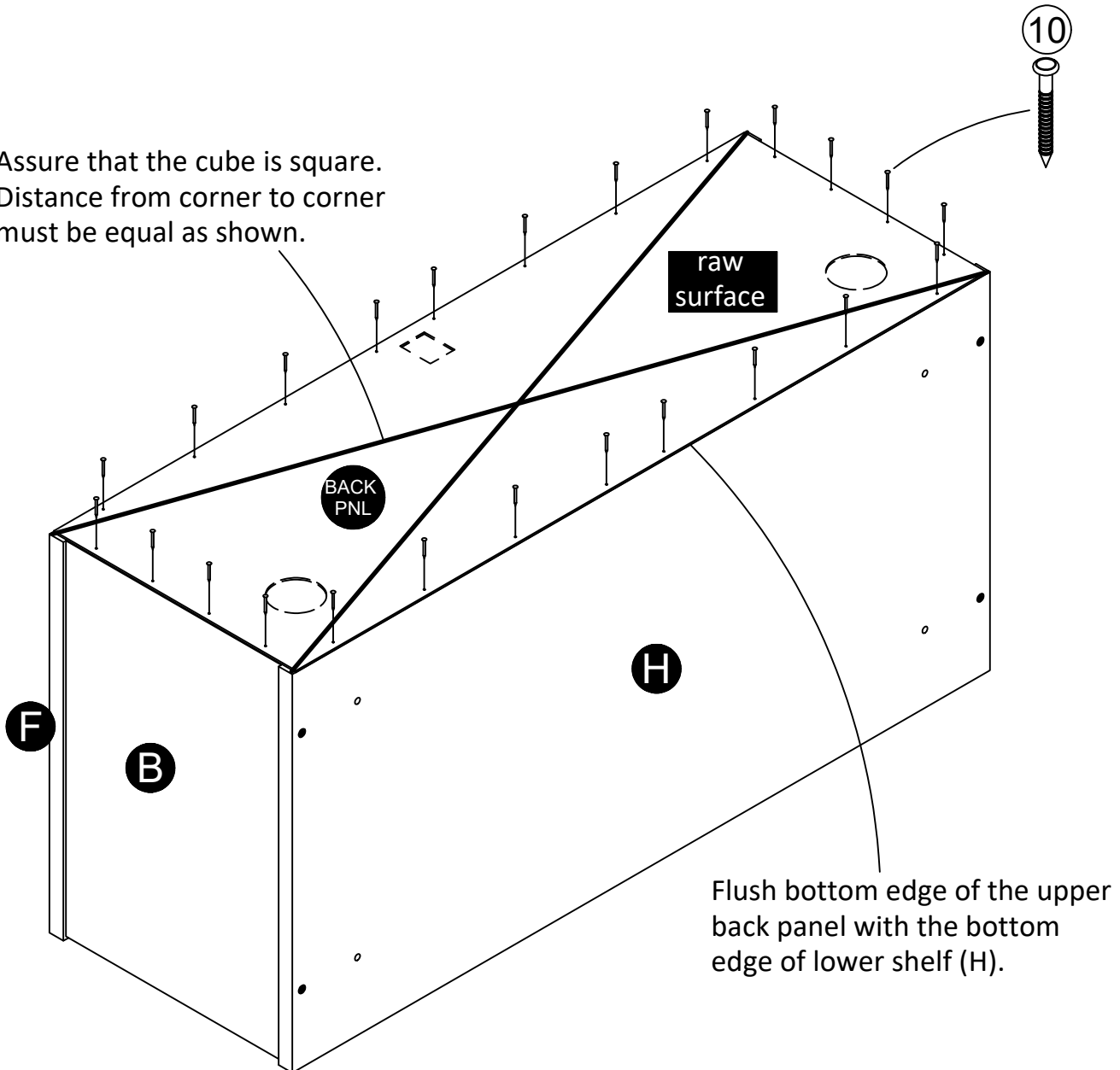

STEP 9

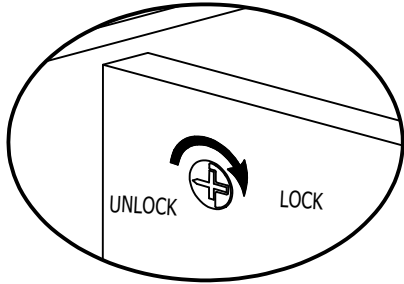
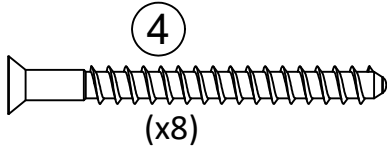
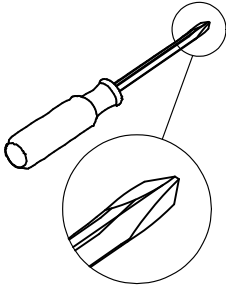

finished edges face up

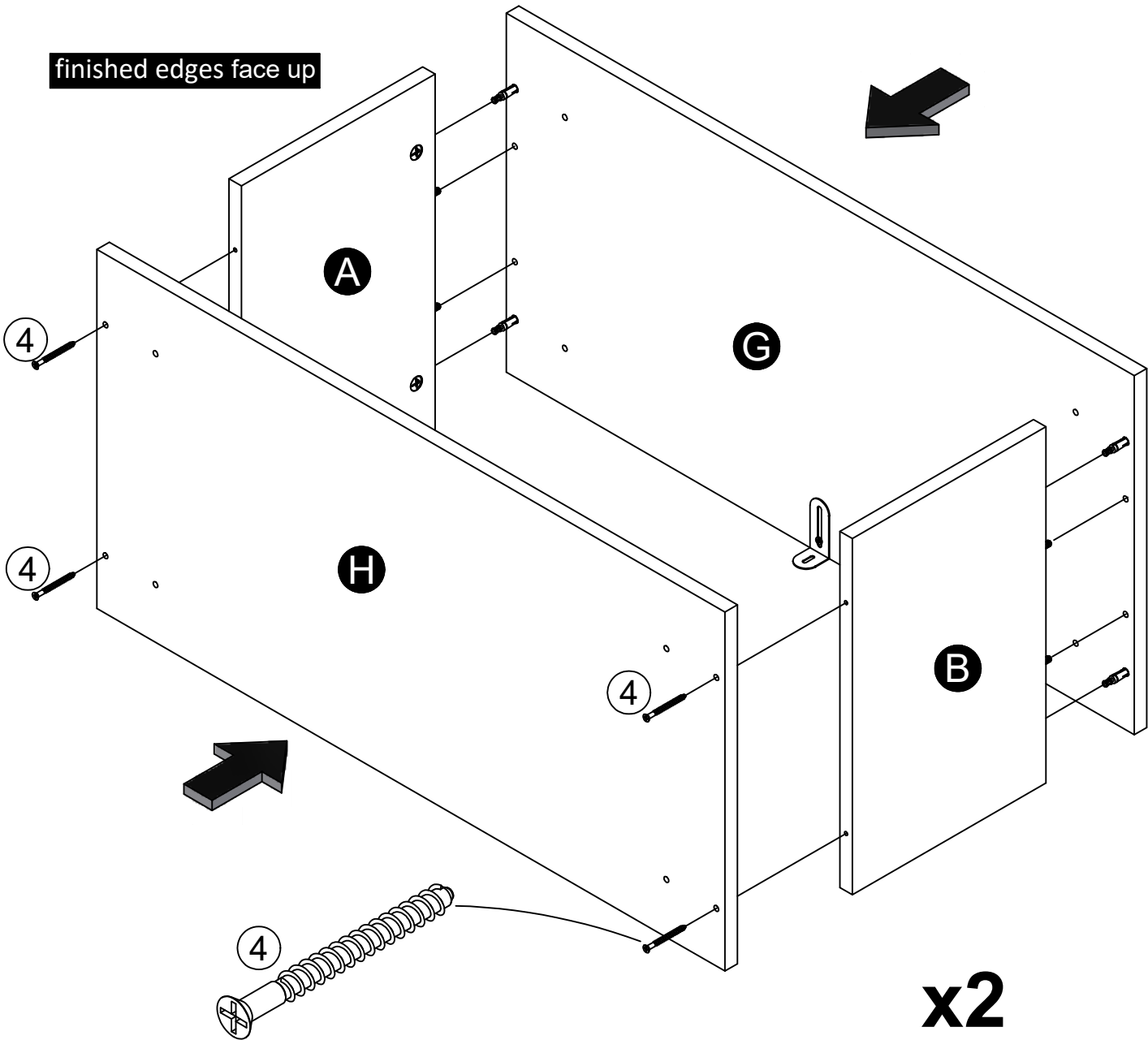

STEP 10

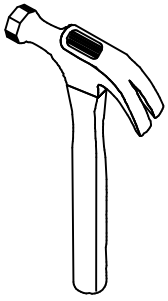

IMPORTANT! THE BACK PANEL IS A STRUCTURAL PART OF THIS UNIT AND MUST BE INSTALLED PROPERLY.

Attached the back panel as shown nailing straight into the raw edges.

NOTE:
One cube will have the safety bracket.

Assure that the cube is square.
Distance from corner to corner
must be equal as shown.

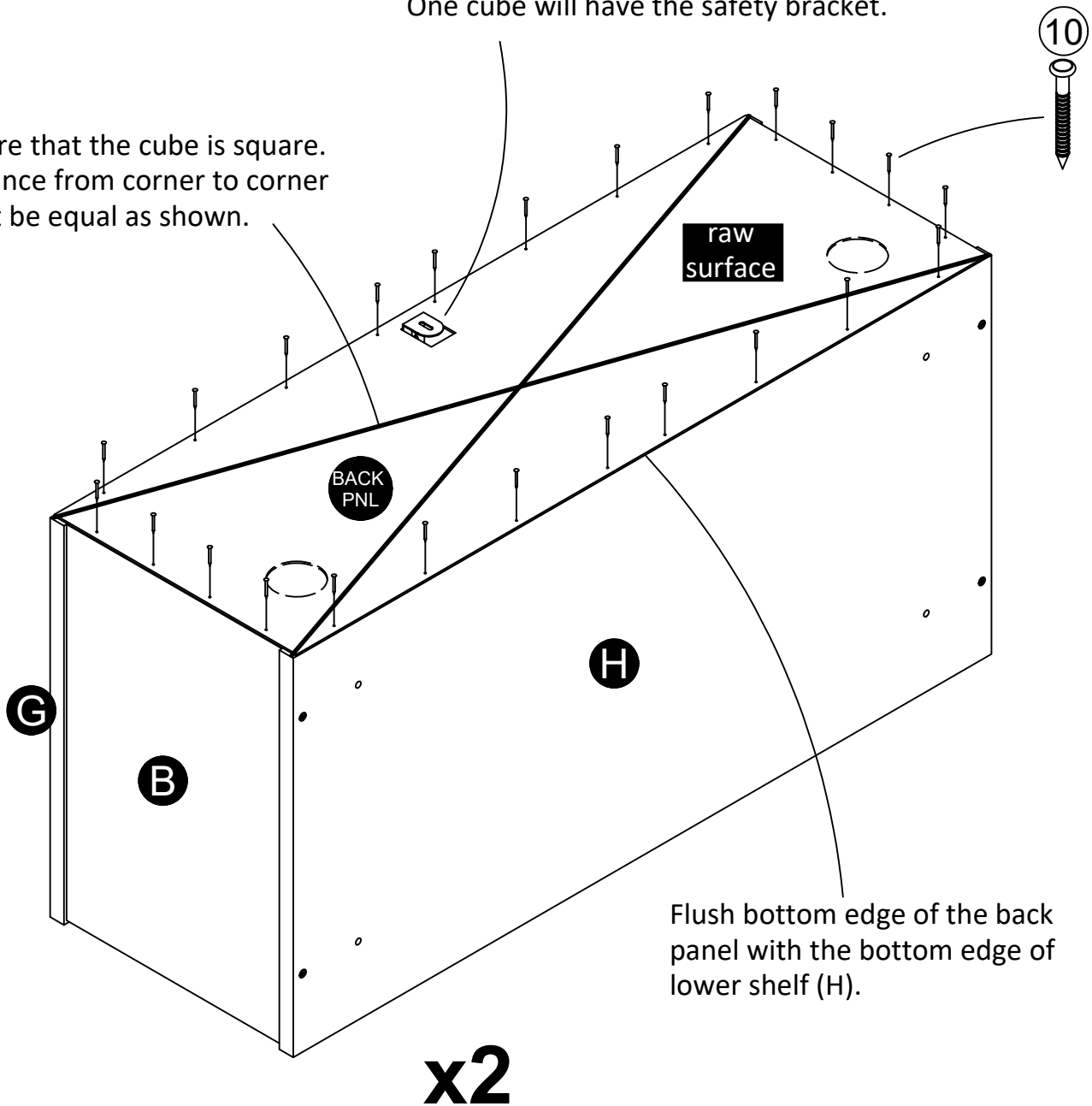

STEP 11

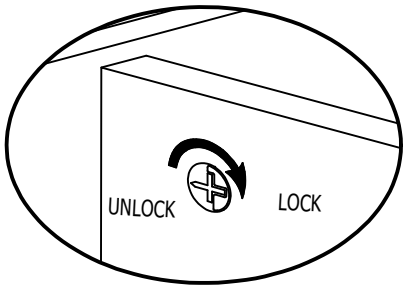
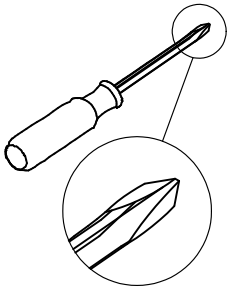

Finished Edges Face Up

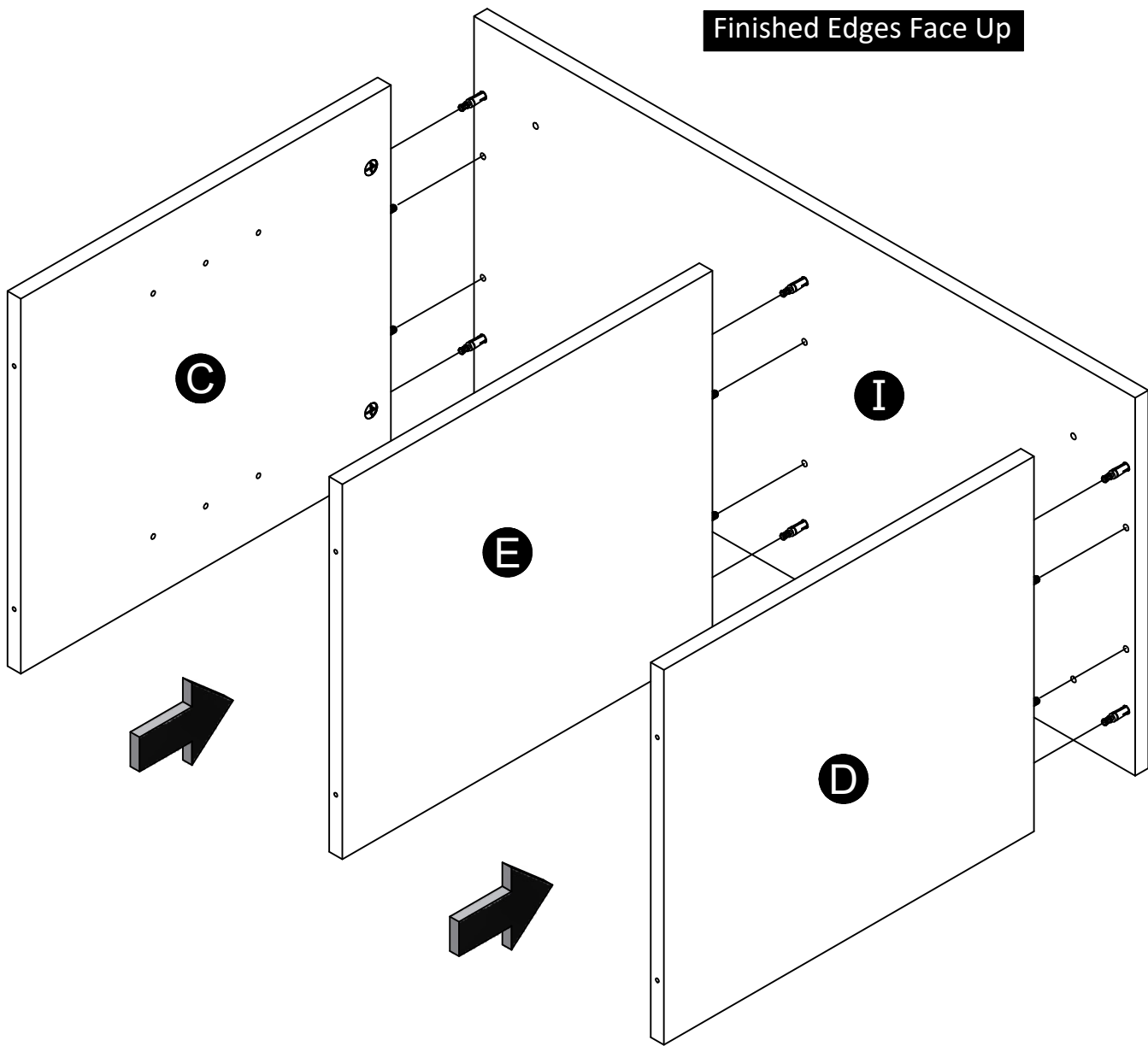

STEP 12

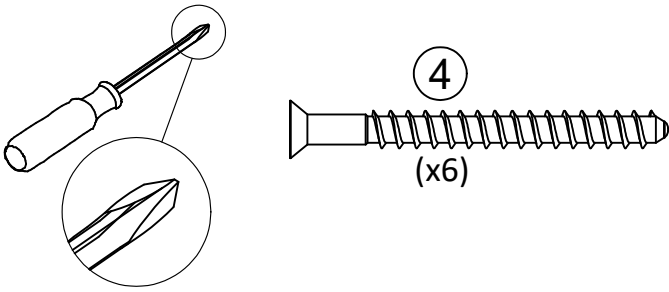

Finished Edges Face Up

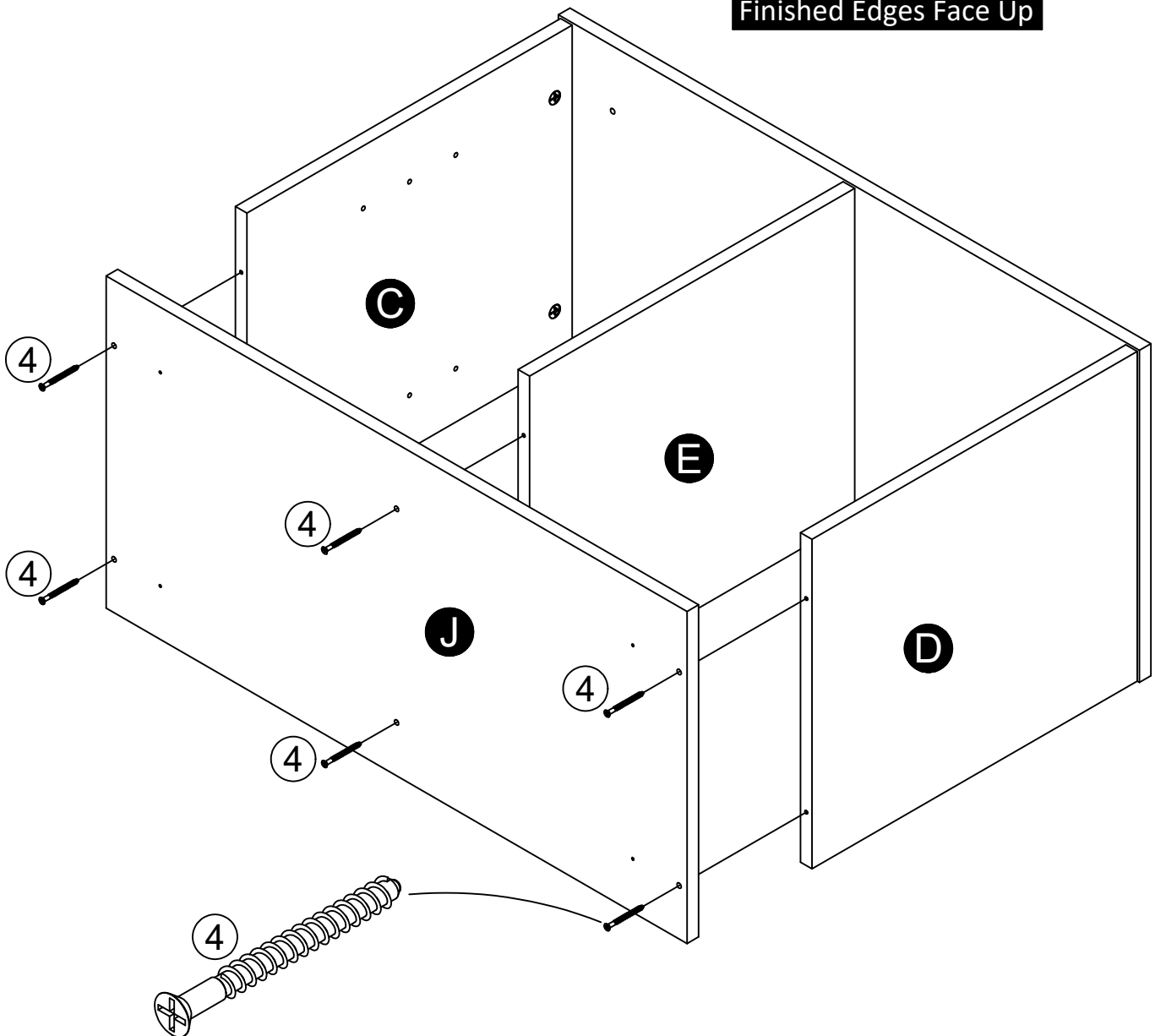

STEP 13

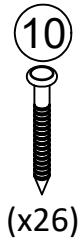
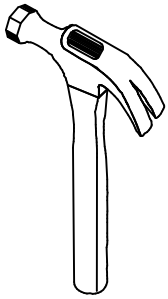

IMPORTANT! THE BACK PANEL IS A STRUCTURAL PART OF THIS UNIT AND MUST BE INSTALLED PROPERLY.

Attached the back panel as shown nailing straight into the raw edges.

Assure that bottom section is square. Distance from corner to corner must be equal as shown.

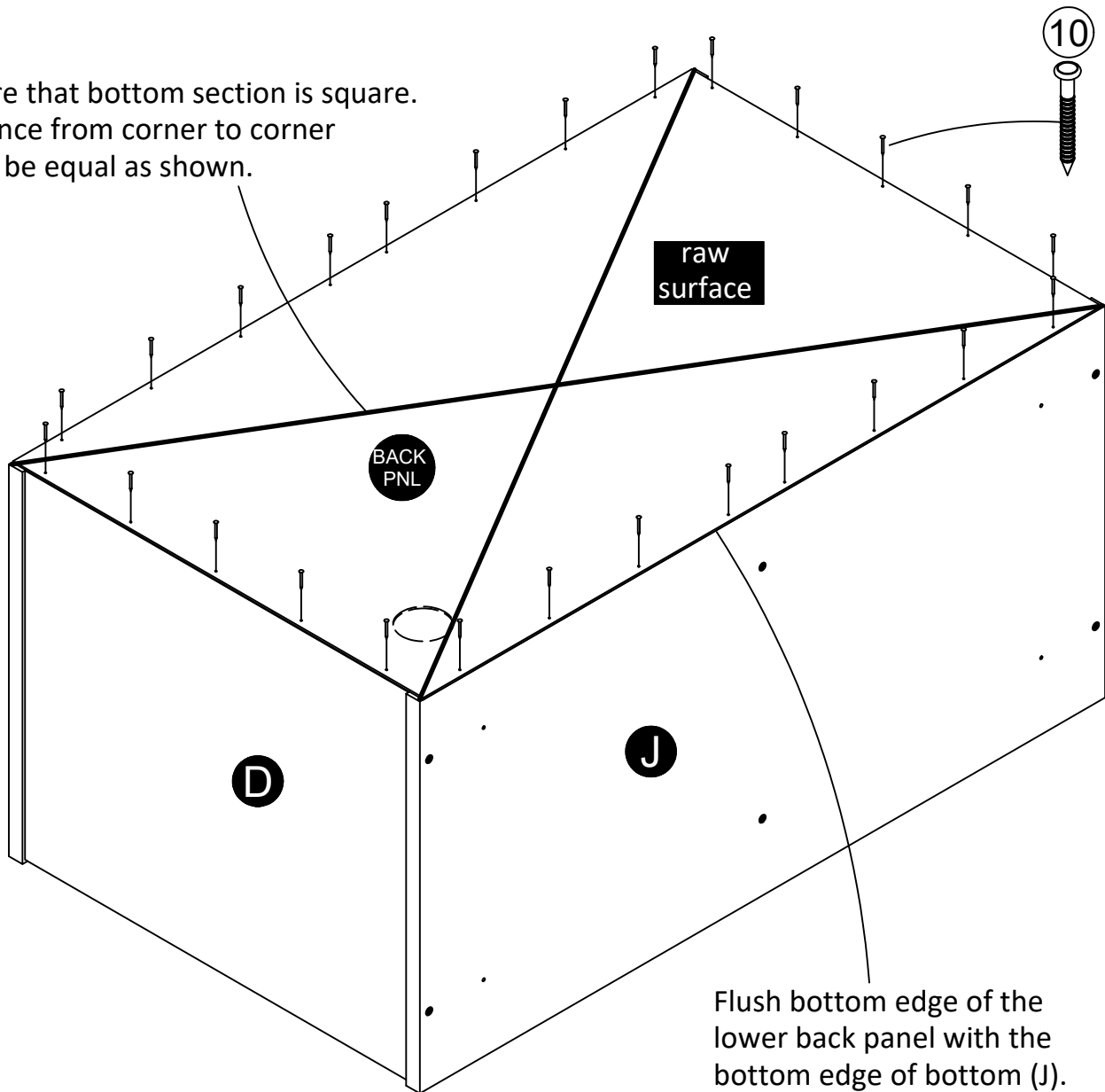

STEP 14

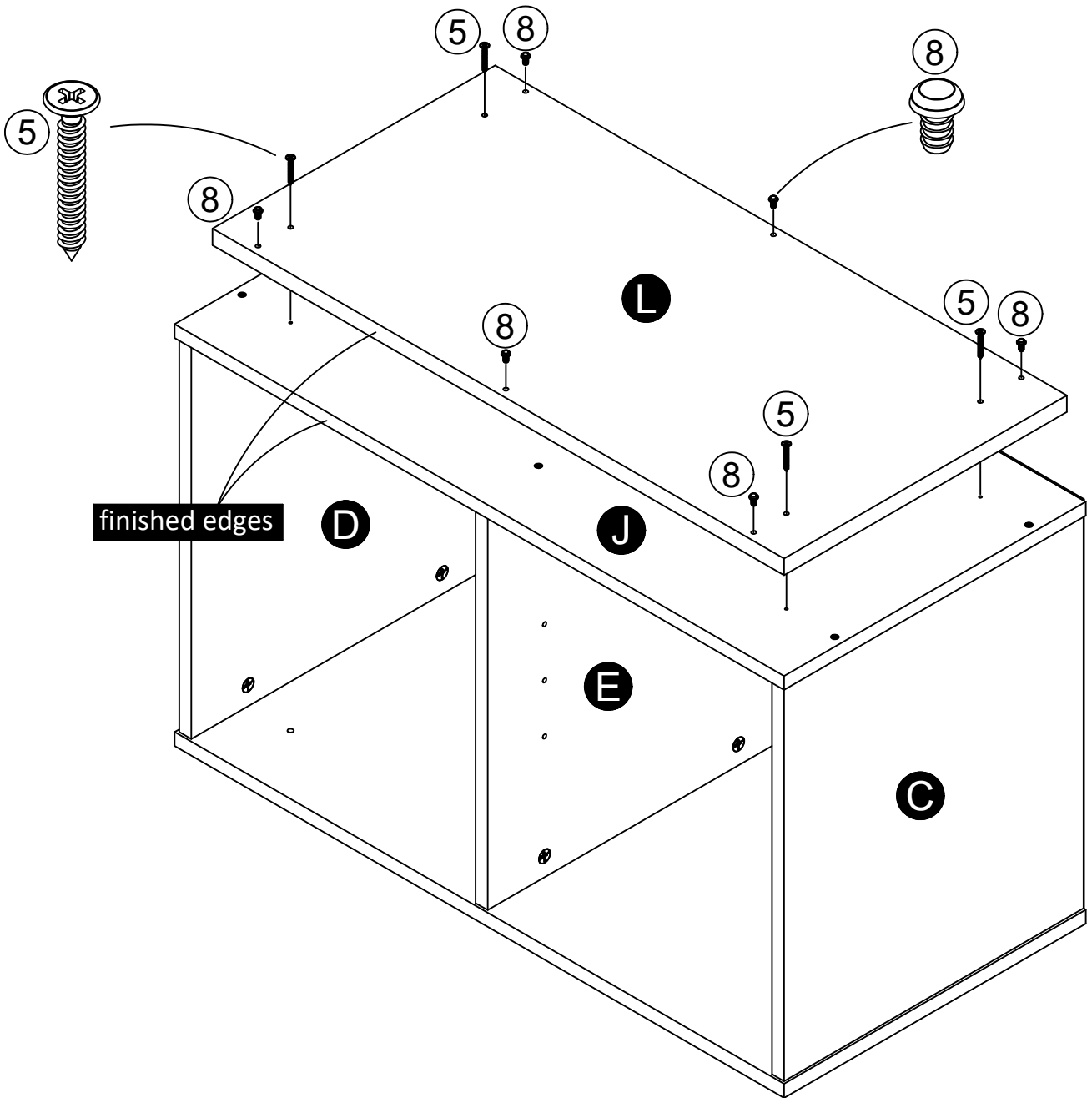
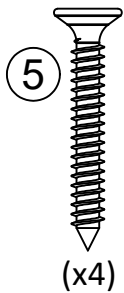
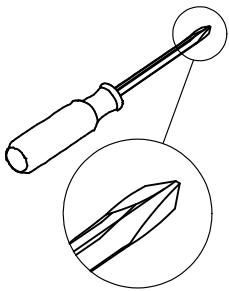

STEP 15

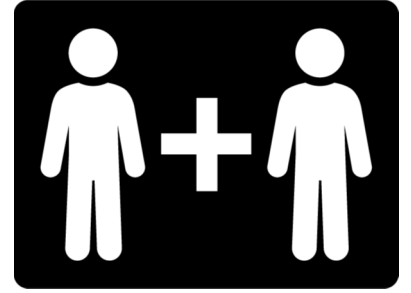
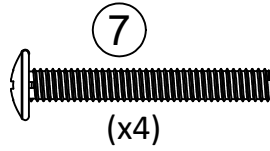
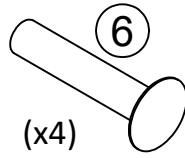
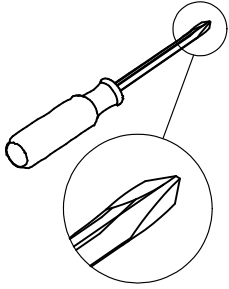

Cube with no
safety bracket.

Finished Edges
Face Out

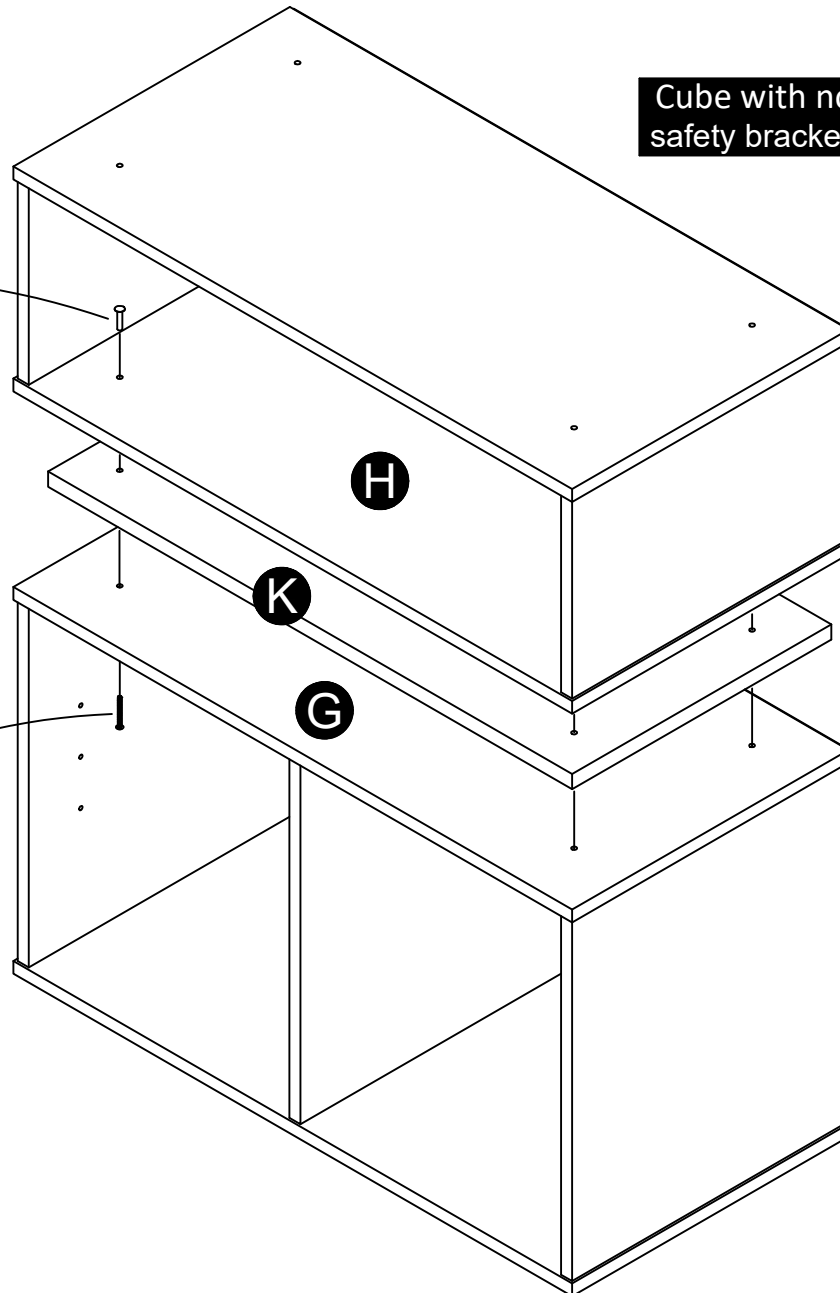
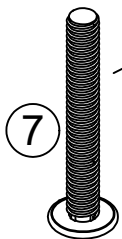
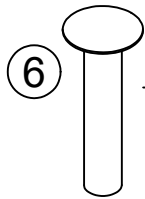

STEP 16

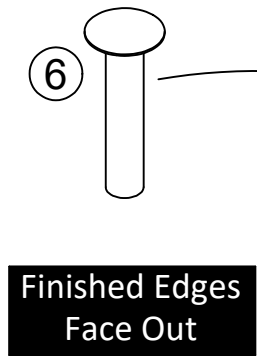
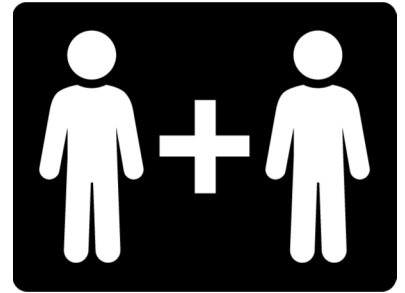
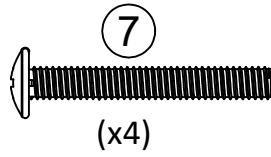
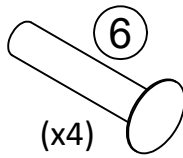
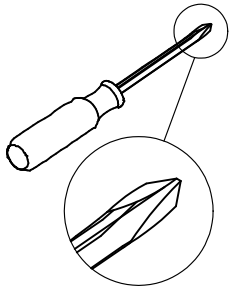

Finished Edges
Face Out

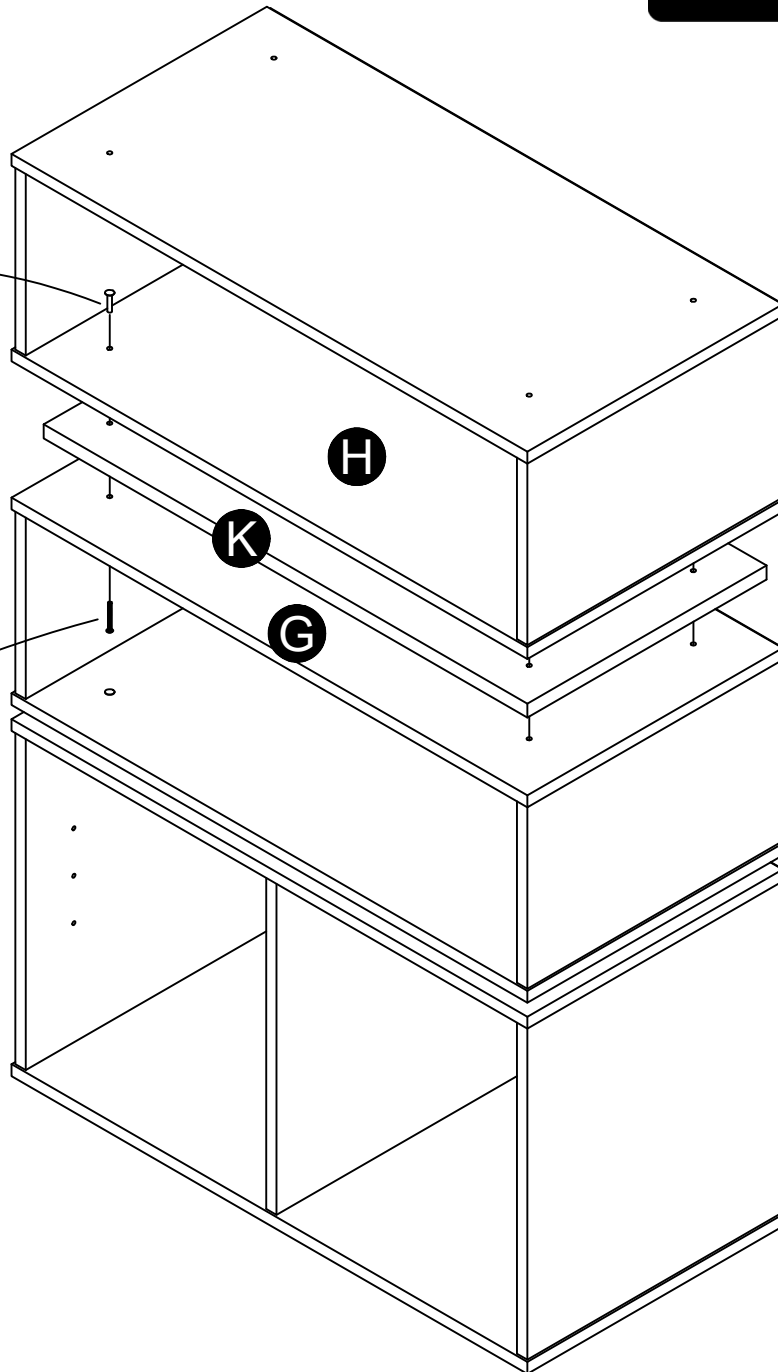
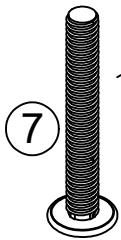

STEP 17

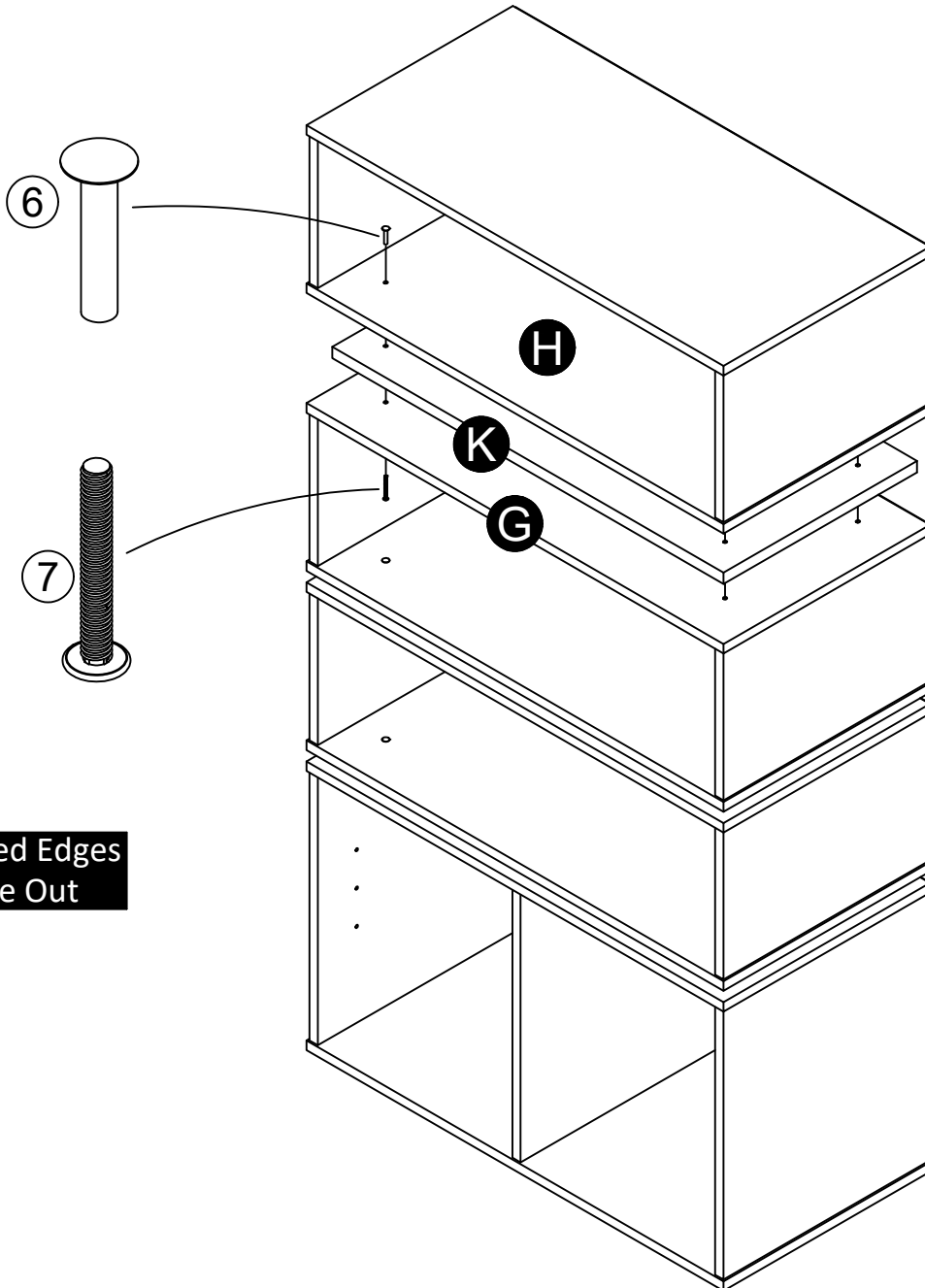
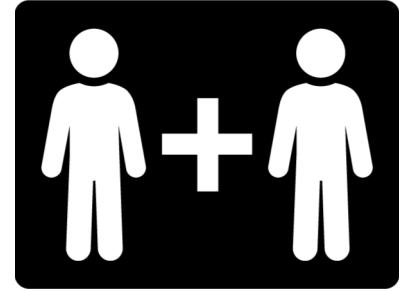
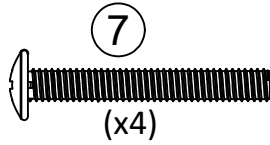
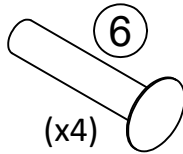
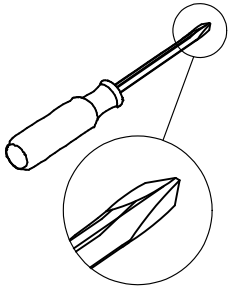

**Finished Edges
Face Out**

STEP 18

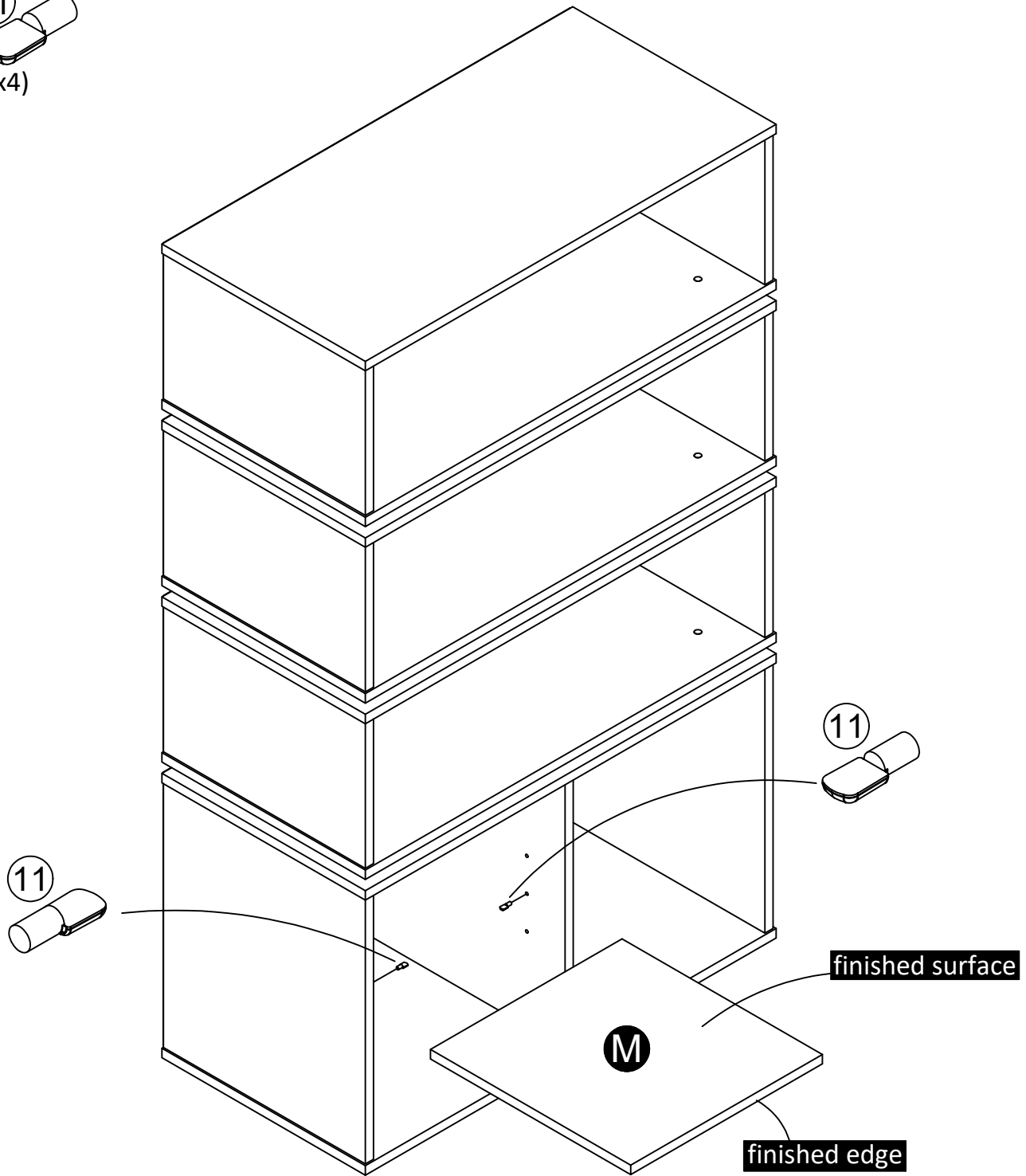
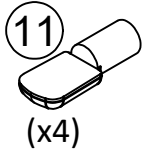

STEP 19

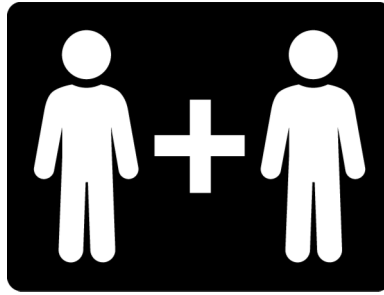
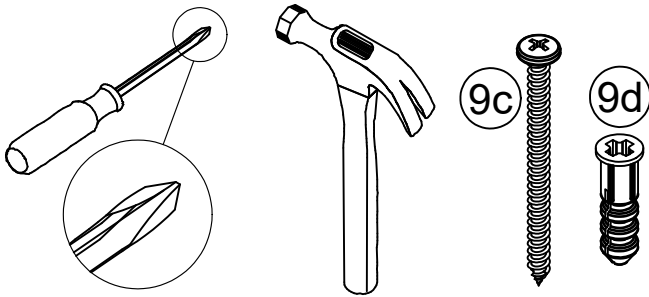

For Masonry, Concrete, or other wall materials: Consult your local hardware store for appropriate anchors to securely attach the safety bracket.

IMPORTANT: THIS UNIT MUST BE SECURE TO THE WALL TO HELP PREVENT TIPOVER. FOLLOW THESE INSTRUCTIONS TO INSTALL THE ANTI-TIPPING SAFETY BRACKET PROVIDED WITH THIS PRODUCT.

With the help of another person, flip the unit on its base and position the unit against the wall.

WARNING

Serious or fatal crushing injuries can occur from furniture tipover.

To prevent tipover:

- * Install tipover restraint provided
- * Place heaviest items in the lowest drawers
- * Unless specifically designed to accommodate, do not set TVs or other heavy objects on the top of this product
- * Never allow children to climb or hang on drawers, door, or shelves
- * Never open more than one drawer at a time

Use of tipover restraints may only reduce, but not eliminate the risk of tipover

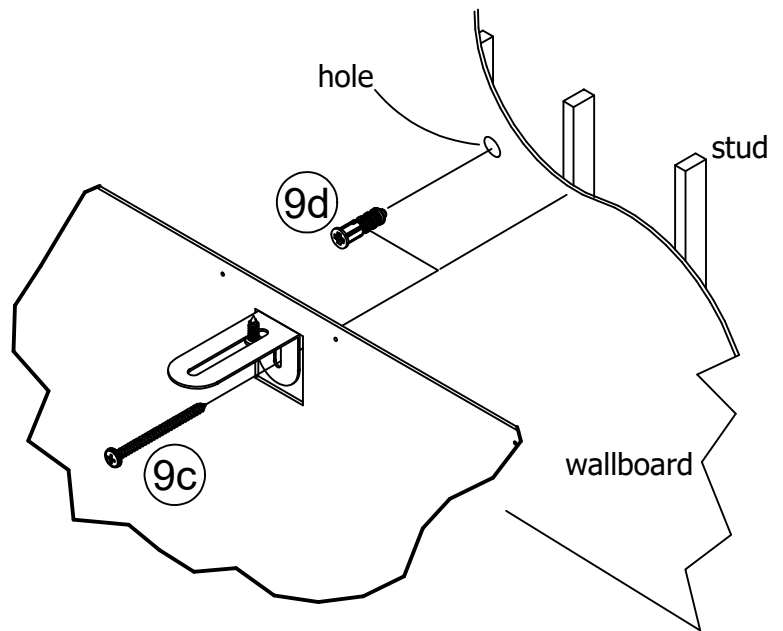

OPTION 1: Attachment into a wall stud (preferred method)

Using a stud finder, locate a stud in the wall. Place your unit against the wall, with the safety bracket aligned in this location. To make driving the screw easier, you can drill a 1/8" diameter pilot hole (3mm) through the safety bracket into the stud. Drive the screw through the safety bracket into the wall stud. Tighten the screw that was not fully tightened in step 3.

OPTION 2: Attachment into drywall

Locate your unit where desired against a wall and mark the wall through the safety bracket, then move your unit aside. Drill a 3/16" diameter hole (5mm) into the wallboard. Tap the wall anchor into the hole until it is flush. Move your unit into location and fasten the wall bracket to the wall anchor with the screw. Tighten the screw that was not fully tightened in step 3.

Maximum Loads

This unit has been designed to support the maximum loads shown. Exceeding these load limits could cause sagging, instability, product collapse, and/or serious injury.

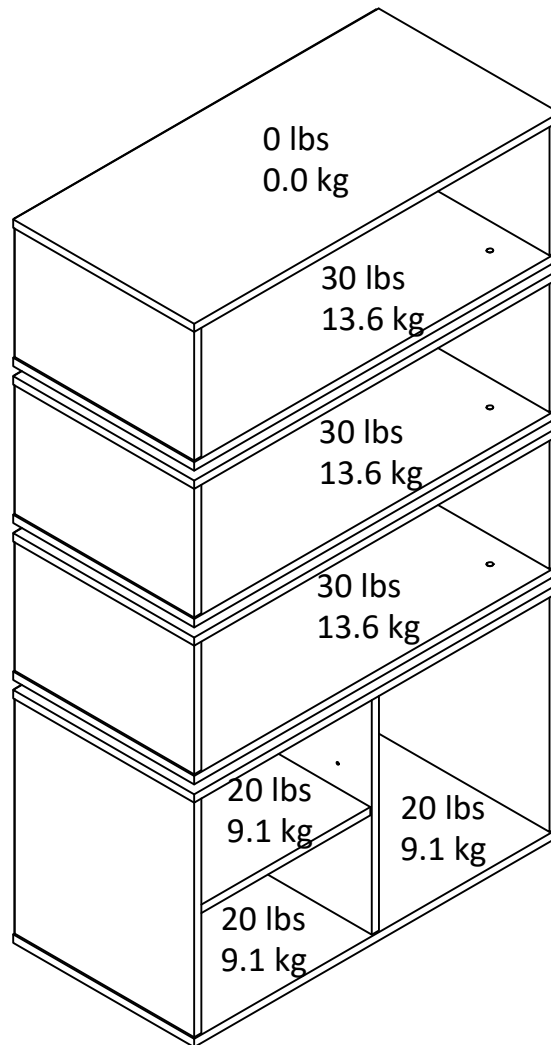

Warning: Risk of injury to persons - do not place a television on this furniture. This furniture is not approved for use with a television.

Certificate of Conformity

1. This certificate applies to the Dorel Home Furnishings, Inc. product identified by this instruction manual.
2. This certificate applies to compliance of this product with the CPSC Ban on Lead-Containing Paint (16 CFR 1303).
3. This product is distributed by: Dorel Home Furnishings, Inc.
410 East First Street South
Wright City, MO 63390
636-745-3351
4. Site of Manufacture: Tiffin OH
5. See front page of instruction manual for date of manufacture.

Register your product to receive the following:



- * New trend details - sneak peek on what's new
- * Surveys - have a voice within our community
- * Exclusive deals and discount codes
- * Quick and easy replacement part service

To register your product, visit ameriwoodhome.com

5 Star Rating



Visit your local retailer's website, rate your purchased product and leave us some feedback!

We would like to extend a big "Thank You" to all of our customers for taking the time to assemble this Ameriwood Home product, and to give us your valuable feedback.

*Thank
You!*

Cubierta Delantera

Este libro de instrucciones contiene información **IMPORTANTE** de seguridad. Por favor lea y manténgalo para referencia en el futuro.

No Regrese este producto! Comuníquese con nuestro amigoso equipo de servicio al cliente para obtener ayuda.

Llámenos al: 1-800-489-3351 (Gratis) Lunes - Viernes 9am - 5pm CST

Visitar: www.ameriwoodhome.com

PRECAUCION

Este mueble puede volcarse y causar graves heridas y/o muerte.

Anclar el mueble a un poste de madera en la pared (si esto se requiere).

No Permita que los niños monten el mueble.

Mantenga los artículos más pesados en los cajones de abajo.

Consejos Útiles (página 2)

- Abra su artículo en el área donde usted planea utilizarlo para evitar levantar y moverlo menos
- Identificar, ordenar y contar las piezas antes de intentar ensamblar
- Las clavijas de compresión se golpean con un martillo
- Las diapositivas están marcadas con una R (derecha) y L (izquierda) para la colocación correcta
- Asegúrese de que siempre este el punto localizado en la parte superior de bloqueador de leva este volteado hacia borde exterior
- Utilizar todos los clavos para el panel de atrás y distribuirlos por igual
- El panel de atrás debe utilizarse para asegurarse de que la unidad quede fija y firme
- No use químicas fuertes ni limpiadores abrasivos en este artículo
- Nunca empuje, tire ni arrastre los muebles

Antes de Que Empieces (página 3)

- Lea cuidadosamente cada paso y siga el orden correcto
- Separar y contar todas sus piezas y hardware
- Dése suficiente espacio para el proceso de ensamble
- Tenga las siguientes herramientas: destornillador de cabeza plana, #2 cabeza Phillips
Destornillador y martillo
- Precaución: Si usa un taladro electrónico o un destornillador eléctrico para atornillar, por favor asegúrese que deje de atornillar cuando el tornillo este apretado. Fallar hacer esto puede causar barrer el tornillo.

Sistema de fijar el bloqueo de leva (página 3)

Esta sistema de fijar el bloqueo de leva sera usado en todo el proceso ensamble.

Página 10

NOTA:

Fijará el soporte de seguridad a un (1) estante superior (G).

No apriete completamente el tornillo.

Página 15 / 17

¡IMPORTANTE! EL PANEL TRASERO ES UNA PARTE ESTRUCTURAL DE ESTA UNIDAD Y DEBE INSTALARSE CORRECTAMENTE.

Fije el panel trasero como se muestra fijándolo con clavos en los bordes sin rematar.

Asegúrese de que el bloque es cuadrado.

La distancia de esquina a esquina debe ser igual, tal como se muestra.

Alinee el borde inferior del panel posterior superior con el borde inferior del estante inferior (H).

Página 17

NOTA:

Un bloque tendrá el soporte de seguridad.

Página 20

¡IMPORTANTE! EL PANEL TRASERO ES UNA PARTE ESTRUCTURAL DE ESTA UNIDAD Y DEBE INSTALARSE CORRECTAMENTE.

Fije el panel trasero como se muestra fijándolo con clavos en los bordes sin rematar.

Asegúrese de que el cubo es cuadrado.

La distancia de esquina a esquina debe ser igual como se muestra.

Alinee el borde inferior del panel trasero inferior con el borde inferior del fondo (J).

Página 26

Para mampostería, hormigón u otros materiales de pared:

Consulte en su ferretería local los anclajes adecuados para fijar firmemente el soporte de seguridad.

¡IMPORTANTE! ESTA UNIDAD DEBE FIJARSE A LA PARED PARA EVITAR QUE VUELQUE. SIGA ESTAS INSTRUCCIONES PARA INSTALAR EL SOPORTE DE SEGURIDAD ANTIVUELCO INCLUIDO CON ESTE PRODUCTO.

Con la ayuda de otra persona, voltee la unidad sobre su base y colóquela contra la pared..

ADVERTENCIA

El vuelco del mueble puede provocar lesiones graves o mortales por aplastamiento.

Para evitar que se vuelque:

- * Instale el soporte antivuelco proporcionado
- * Coloque los objetos más pesados en los cajones más bajos.
- * A menos que esté específicamente diseñado para ello, no coloque televisores u otros objetos pesados encima de este producto.
- * Nunca permita que los niños trepen o se cuelguen de los cajones, la puerta o los estantes.
- * Nunca abra más de un cajón a la vez

El uso de soportes antivuelco solo reduce, pero no elimina, el riesgo de vuelco.tipover

OPCIÓN 1: Fijación en un soporte de pared (método recomendado)

Con un localizador de vigas, localice una viga en la pared. Coloque la unidad contra la pared, con el soporte de seguridad alineado en esta ubicación. Para facilitar la colocación del tornillo, puede taladrar un orificio guía de 1/8" de diámetro (3 mm) a través del soporte de seguridad en la viga. Introduzca el tornillo a través del soporte de seguridad en la viga de la pared. Apriete el tornillo que no se apretó completamente en el paso 3.

OPCIÓN 2: Fijación en paneles de yeso

Ubique su unidad donde desee contra una pared y marque la pared a través del soporte de seguridad, luego mueva su unidad a un lado. Taladre un agujero de 3/16" de diámetro (5 mm) en la pared. Introduzca el anclaje de pared en el orificio hasta que quede enrasado. Coloque la unidad en su sitio y fije el soporte de pared al anclaje de pared con el tornillo. Apriete el tornillo que no estaba completamente apretado en el paso 3.

Página 27

CARGA MAXIMA

Esta unidad ha sido diseñada para soportar las cargas máximas indicadas. Exceder estos límites de carga podría causar pandeo, inestabilidad, desplome del producto y/o lesiones graves.

Advertencia: Riesgo de lesiones personales, no coloque un televisor sobre este mueble. Este mueble no está homologado para la colocación de un televisor.

Página 28

Registre su producto para recibir lo siguiente:

- * Detalles de nuevas tendencias - Vistazo a lo nuevo
- * Encuestas - alec su voz entre su comunidad
- * Códigos de ofertas y descuentos exclusivos
- * Fácil y rápido servicio de partes de remplace

Para registrar su producto, visite ameriwoodhome.com

Clasificación de 5 estrellas

Visite el sitio web de su tienda local, califique su comprado y denos sus comentarios!

Nos gustaría enviar un gran "Agradecimiento" a todos nuestros clientes por tomarse el tiempo de ensamblar este producto de Ameriwood Home, y por darnos sus valiosos comentarios.

Gracias

Couverture Avant

CE LIVRET D'INSTRUCTION CONTIENT DES INFORMATIONS **IMPORTANTES** SUR LA SÉCURITÉ. VEUILLEZ LIRE ET GARDER POUR UNE RÉFÉRENCE FUTURE

Ne retournez pas ce produit! Contactez notre équipe de service à la clientèle amicale d'abord pour obtenir de l'aide.

Appelez-nous: 1-800-489-3351 (sans frais) du Lundi au Vendredi de 9h à 17h Heure Centrale

Visitez: www.ameriwoodhome.com

ATTENTION

Le meuble peut basculer et causer des blessures graves ou la mort.

Ancrer le meuble à une planche murale dans le mur (si indiqué).

Ne laissez pas les enfants grimper sur le meuble.

Placez les articles lourds sur les étagères ou dans les tiroirs inférieurs.

Astuces Utiles (page 2)

-Ouvrez votre article dans la zone que vous prévoyez de le garder pour moins de levage lourd

-Identifier, trier et compter les pièces avant d'essayer d'assembler

-Les goujons de compression sont taraudés avec un Marteau

-Les glissières sont marquées d'un R (droit) et d'un L (gauche) pour un bon placement

-Assurez-vous toujours de faire face la pointe situé sur le haut de la Serrure de Came vers le bord extérieur

-Utiliser tous les clous fournis pour le panneau arrière et les répartir également

-Le panneau arrière doit être utilisé pour vous assurer que votre appareil est robuste

-N'utilisez pas de produits chimiques agressifs ou de nettoyeurs abrasifs sur cet appareil

-Ne jamais pousser, tirer, ou faire glisser votre meuble

Avant de Commencer (page 3)

-Lisez attentivement chaque étape et suivez le bon ordre

-Séparez et comptez toutes vos pièces et matériaux

-Donnez-vous suffisamment de place pour l'assemblage

-Avoir les outils suivants: tournevis à tête plate, #2 tournevis Phillips, et Marteau

-Attention: Si vous utilisez une perceuse électrique ou un tournevis électrique pour visser, veillez à ralentir et arrêter lorsque la vis est bien serrée. Le non-respect de cette consigne peut endommager la vis.

Système de Fixation de Came (page 3)

Ce Système de Fixation de Came sera utilisé tout au long de l'assemblage

Page 10

REMARQUE :

Vous fixerez le support de sécurité à une (1) étagère supérieure (G).

Ne pas serrer complètement la vis.

Page 15 / 17

IMPORTANT! LE PANNEAU ARRIÈRE EST UNE PARTIE STRUCTURELLE DE CET APPAREIL ET DOIT ÊTRE INSTALLÉ CORRECTEMENT.

Fixez le panneau arrière comme indiqué en clouant directement dans les bords bruts.

Assurez-vous que le cube est bien carré.

La distance d'un coin à l'autre doit être égale, comme illustré.

Alignez le bord inférieur du panneau arrière supérieur avec le bord inférieur de la tablette inférieure (H).

Page 17

REMARQUE :

Un cube aura le support de sécurité.

Page 20

IMPORTANT! LE PANNEAU ARRIÈRE EST UNE PARTIE STRUCTURELLE DE CET APPAREIL ET DOIT ÊTRE INSTALLÉ CORRECTEMENT.

Fixez le panneau arrière comme indiqué en clouant directement dans les bords bruts.

Assurez-vous que le cube est bien carré.

La distance d'un coin à l'autre doit être égale, comme illustré.

Alignez le bord inférieur du panneau arrière inférieur avec le bord inférieur du fond (J).

Page 26

Pour la maçonnerie, le béton ou d'autres matériaux muraux :

Consultez votre quincaillerie locale pour obtenir les ancrages appropriés afin de fixer solidement le support de sécurité.

IMPORTANT : CET APPAREIL DOIT ÊTRE FIXÉ AU MUR POUR ÉVITER TOUT BASCULEMENT. SUIVEZ CES INSTRUCTIONS POUR INSTALLER LE SUPPORT DE SÉCURITÉ ANTI-BASCULEMENT FOURNI AVEC CE PRODUIT.

Avec l'aide d'une autre personne, retournez l'appareil sur sa base et positionnez-le contre le mur.

AVERTISSEMENT

Le basculement d'un meuble peut entraîner des blessures graves ou mortelles par écrasement.

Pour éviter le basculement :

- * Installer le dispositif de retenue en cas de basculement fourni
- * Placez les articles les plus lourds dans les tiroirs les plus bas
- * Ne posez pas de téléviseurs ou d'autres objets lourds sur le dessus de ce produit, à moins qu'ils ne soient spécifiquement conçus pour cela
- * Ne permettez jamais aux enfants de grimper ou de s'accrocher aux tiroirs, aux portes ou aux étagères
- * N'ouvrez jamais plus d'un tiroir à la fois

L'utilisation de dispositifs de retenue en cas de basculement ne peut que réduire, mais pas éliminer, le risque de basculement

OPTION 1 : Fixation dans un montant de mur (méthode préférée)

À l'aide d'un détecteur de montants, localisez un montant dans le mur. Placez votre appareil contre le mur, avec le support de sécurité aligné à cet endroit. Pour faciliter l'insertion de la vis, vous pouvez percer un trou pilote de 1/8 po de diamètre (3 mm) à travers le support de sécurité dans le montant. Enfoncez la vis à travers le support de sécurité dans le montant du mur. Serrez la vis qui n'a pas été entièrement serrée à l'étape 3.

OPTION 2 : Fixation dans les cloisons sèches

Placez votre appareil à l'endroit souhaité contre un mur et marquez le mur à travers le support de sécurité, puis mettez votre appareil de côté. Percez un trou de 3/16 po de diamètre (5 mm) dans le panneau mural. Tapez sur l'ancrage mural dans le trou jusqu'à ce qu'il soit affleurant. Mettez votre appareil en place et fixez le support mural à l'ancrage mural à l'aide de la vis. Serrez la vis qui n'a pas été entièrement serrée à l'étape 3.

Page 27

CHARGES MAXIMALES

Cet appareil a été conçu pour supporter les charges maximales indiquées. Le dépassement de ces limites de charge peut entraîner un affaissement, une instabilité, un effondrement du produit et/ou des blessures graves.

Avertissement : Risque de blessure pour les personnes - ne pas placer un téléviseur sur ce meuble. Ce meuble n'est pas homologué pour être utilisé avec un téléviseur.

Page 28

Enregistrez votre produit pour recevoir les éléments suivantes:

- * Détails sur les nouvelles tendances - un aperçu sur les nouveautés
- * Sondages - avoir une voix au sein de notre communauté
- * Offres exclusives et codes promo
- * Service de pièces de rechange rapide et facile

Pour enregistrer votre produit, visitez ameriwoodhome.com

5 Étoiles

Visitez le site Web de votre détaillant local, évaluez votre produit acheté et laissez-nous quelques commentaires !

Nous tenons à offrir un grand "Merci" à tous nos clients pour avoir pris le temps d'assembler ce produit "Ameriwood Home", et de nous donner vos commentaires précieux.

Merci